

ACS 200

**Frequency Converters  
for Speed Control of  
0.55 to 4.0 kW  
Squirrel Cage Motors**

**Supply Voltage  
208 to 240 V  
380 to 480 V**

**User's Manual**



**ABB**

**Keep this User's Manual within easy reach.**

## **Warning symbols**

For your own safety please pay special attention to instructions containing these symbols:



This warning symbol indicates the presence of dangerous voltage. It informs you of high voltage conditions, situations and locations that may cause death or serious injury if you do not follow precautions and proper steps.



This symbol indicates a general warning.



This warning symbol indicates an electrostatic discharge hazard.

---

**NOTES** inform you of situations or conditions which will damage machinery or cause additional motor-operation down-time if you do not take suggested steps to correct or address such situations or conditions.

---

**ACS 200 Frequency Converters  
for Speed Control of  
0.55 to 4.0 kW  
Squirrel Cage Motors**

**Supply voltage  
208 to 240 V  
380 to 480 V**

User's Manual

Code: EN 5805765-7  
20HBC-UML1A1/EN  
1994-10-26/MM  
V:\GSVBC\ACS200\EN

# Safety Instructions

---

## Warnings and notes

Note that the Main Circuit Card of the ACS 200 is at mains supply voltage potential.



**Warning!** The d.c. bus capacitors on the Main Circuit Card contain dangerous d.c. voltages ( $1.35 * U_{240}$ ,  $1.3 * U_{480}$ ). After disconnecting the supply, wait at least **five minutes** and ensure that the display readout on the control panel and the "DANGER" (200 V series) or "CHARGE" (400 V series) LED indication on the bottom left corner of the Main Circuit Card have disappeared before taking any action within the ACS 200.

---



**Warning!** Dangerous external control voltages may be present on the relay output of the Control Card.

---



**Warning!** The frequency converter contains dangerous voltages when connected to the mains. Always check that the ACS 200 is safe, after disconnecting the power, by measuring the mains input (Main Circuit Card terminal block X1), refer to figure 3-1 on page 16. Failure to check voltages could cause death or serious injury. Only a competent electrician should carry out the electrical installation.

---



**Note!** Static voltage can damage electronic circuits. Avoid touching any of the components within the ACS 200.

---



**Note!** The motor rotational direction can be locked to forward only by using the DIR parameter. See page 42 for more details.

---



**Warning!** Altering the parameter settings or device configurations will affect the function and performance of the ACS 200. Check that these changes do not cause any risk to persons or property.

---



**Warning!** Mechanical faults on the motor, power failure or other faults may cause stoppages. Correcting the fault may cause the motor to restart. Take all necessary precautions to ensure personnel safety and to avoid damage to equipment and property before motor restart.

---



**Warning!** Certain parameter settings and external control signals may cause the ACS 200 to start up automatically after an input power failure.

---

**Note!** To ensure safe operation, due regard should be given by the installer to the local safety regulations such as the EC Machinery Directive 89/392/EEC.

---

# Contents

<b>Safety Instructions</b> .....	<b>2</b>
<b>1 Overview of the ACS 200</b> .....	<b>5</b>
How to use this manual .....	5
Intended audience .....	5
Guarantee and liability information .....	5
Related documentation .....	6
Delivery checks .....	6
General information about ACS 200 .....	7
<b>2 Mechanical Installation</b> .....	<b>9</b>
Cooling.....	9
Mounting .....	11
<b>3 Power Connections</b> .....	<b>13</b>
Mains cable .....	13
Motor cable .....	13
Insulation checks .....	14
Terminal connections .....	15
<b>4 Control Connections</b> .....	<b>17</b>
Control cables.....	17
Control Card connections .....	18
Input/output option selection .....	19
<b>5 Control and Parameter Logic</b> .....	<b>23</b>
Control Panel.....	23
Panel operation .....	24
Parameter logic .....	26

<b>6 Commissioning .....</b>	<b>27</b>
Safety precautions .....	27
Commissioning checklist .....	27
Installation inspection .....	28
Checking the parameters .....	28
Keypad control tests .....	28
<b>7 Drive Parameters .....</b>	<b>30</b>
Parameter tables .....	30
Page 1 parameters .....	32
Page 2 parameters .....	34
<b>8 Fault Tracing .....</b>	<b>44</b>
Fault indications .....	44
Fault resetting .....	44
Fault memory .....	44
Fault tracing .....	45
<b>9 Technical Data .....</b>	<b>48</b>
<b>10 Glossary .....</b>	<b>50</b>
<b>Index .....</b>	<b>53</b>

# 1 Overview of the ACS 200

---

## How to use this manual

The purpose of this manual is to provide you with the information necessary to install, start-up, operate and service an ACS 200 frequency converter. This manual also describes features and functions of the frequency converter and requirements such as external control connections, cabling, cable sizes and routing.

Chapter 9, Technical Data, lists input and output voltages, currents and other useful data for the ACS 200 frequency converter.

Chapter 10, Glossary, lists and defines terms common to all ACS 200 frequency converters.

Index helps you locate the page numbers of topics contained in this manual.

## Intended audience

The audience for this manual has:

- knowledge of standard electrical cabling practices, electronic components and electrical schematic symbols.
- no experience or training in installing, operating or servicing the ACS 200.

With the help of this manual you will be able to install, start-up, operate and service the ACS 200.

## Guarantee and liability information

The guarantee covers defects in manufacture. The manufacturer carries no responsibility for damage occurred during transport or unpacking.

In no event, and under no circumstances, shall the manufacturer be liable for damages and failures due to misuse, abuse, improper installation or abnormal conditions of temperature, dust or corrosives or failures due to operation above rated capacities. Nor shall the manufacturer ever be liable for consequential and incidental damages.

The period of manufacturers' guarantee is 12 months from commissioning and not more than 24 months from the date of delivery.

The local ABB company or distributor may have a different guarantee period, which is specified in their sales terms and conditions and guarantee terms.

The technical data and specifications are valid at the time of printing. ABB reserves the right to subsequent alterations.

If you have any queries concerning the ACS 200, please contact your nearest ACS 200 supplier.

## Related documentation

The following documents have been included in your ACS 200 frequency converter delivery:

- Delivery Card
- Quick Reference Guide (Control Panel operation, parameters, fault tracing)
- User's Manual

## Delivery checks

Read the Delivery Card when you receive the ACS 200 and verify that the delivery is complete and correct (refer to the type designation code presented below) and that the frequency converter is undamaged. In the event of damage, please contact the insurance company involved or the supplier. If the delivery is not in compliance with the order, please contact the supplier immediately.

### Type designation

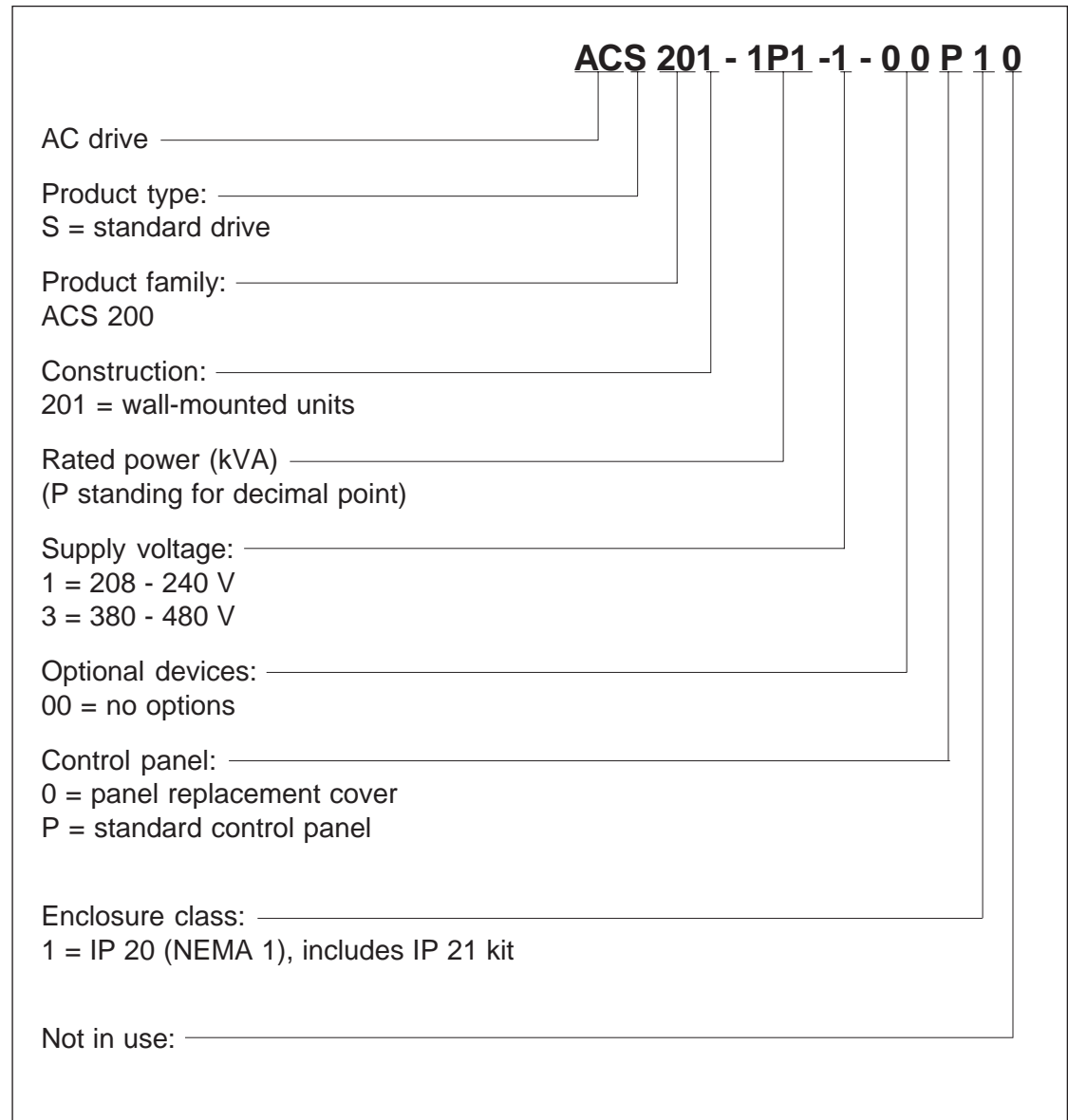

Figure 1-1. Type designation of the ACS 200 product family (code printed on the nameplate located at the right side of the heatsink).



## General information about ACS 200

### Features and functions

Table 1-1. ACS 200 frequency converter types for 50 Hz and 60 Hz supplies. Mains supply 208 to 240 V.

Type designation	Rated input current		Output current		Maximum permissible rated motor power $P_N$ [kW]	Weight [kg]
	1 phase $I_1$ [A]	3 phase $I_1$ [A]	Rated current $I_N$ [A]	Short term over-load current $I_{OVER}$ [A] <sup>1)</sup>		
ACS 201-1P1-1	6.6	-	3.0	4.5	0.55	3.1
ACS 201-1P6-1	8.9	-	4.3	6.5	0.75	3.1
ACS 201-2P1-1	12.2	8.4	5.5	8.3	1.1	4.1
ACS 201-2P7-1	15.7	9.8	7.1	10.7	1.5	4.1
ACS 201-4P1-1	22.4	12.9	10.7	13.0	2.2	4.1

<sup>1)</sup> Allowed for one minute every ten minutes at 40 °C ambient.

Table 1-2. ACS 200 frequency converter types for 50 Hz and 60 Hz supplies. Mains supply 380 to 480 V.

Type designation	Rated input current	Output current		Maximum permissible rated motor power $P_N$ [kW]	Weight [kg]
	3 phase $I_1$ [A]	Rated current $I_N$ [A]	Short term over-load current $I_{OVER}$ [A] <sup>1)</sup>		
ACS 201-1P6-3	3.0	2.5	3.8	0.75	4.1
ACS 201-2P1-3	3.9	3.2	4.8	1.1	4.1
ACS 201-2P7-3	5.0	4.1	6.2	1.5	4.1
ACS 201-4P1-3	7.5	6.2	9.3	2.2	4.1
ACS 201-4P9-3	9.1	7.5	11.0	3.0	4.1
ACS 201-6P6-3	12.1	10.0	15.0	4.0	4.1

<sup>1)</sup> Allowed for one minute every ten minutes at 40 °C ambient.

### Component descriptions

The ACS 200 includes the following components:

- Heatsink
- Main Circuit Card
- Power Module
- Control Card
- Protection Cover
- Control Panel

Input power activates the Line Rectifier of the Main Circuit Card which produces pulsating d.c. voltage to the d.c. circuit. This intermediate d.c. circuit filters the voltage to the Power Module which produces symmetrical three-phase a.c. voltage for the motor. The Power Module used in the frequency converter is the latest IGBT technology with intelligent protection capabilities integrated in the module. The input power is almost entirely active power. Any losses in the Main Circuit Card are dissipated through the air-cooled heatsink.

Voltage waveform conversions and frequency converter status are controlled and monitored by the Main Circuit Card. Interactions between required functions and frequency converter status are controlled by the system software on the Control Card. The Control Card contains the control connections for external operator controls. External control can be either by the removable Control Panel connected to the Control Card or input/output connections from overriding control devices. The Control Panel can fit directly on the frequency converter or externally with an additional cable. The Protection Cover provides the specified protection class.

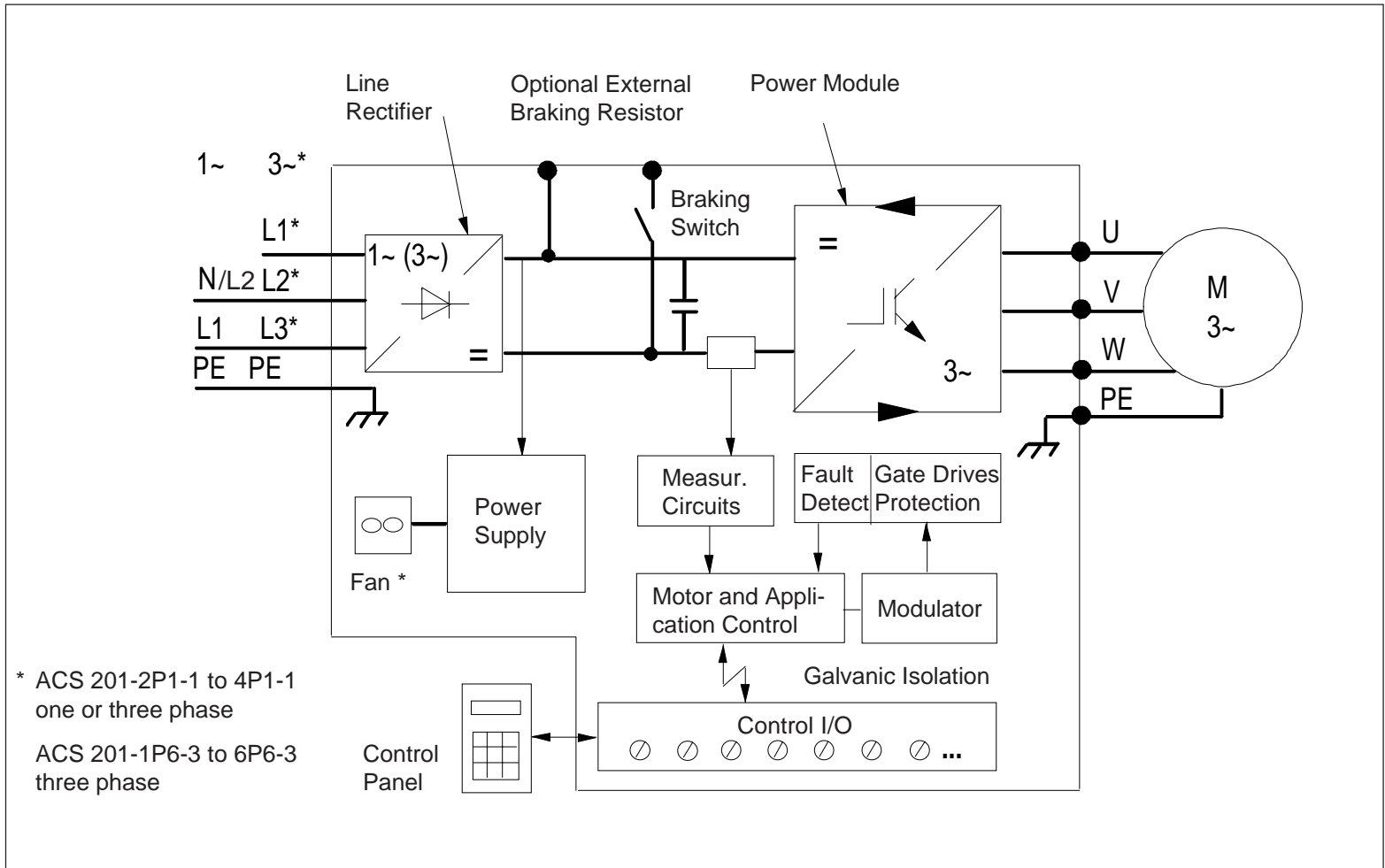

Figure 1-2. ACS 200 block diagram.

## 2 Mechanical Installation

### Cooling

Cooling of the ACS 200 is based on natural air circulation (ACS 201-1P1-1 to ACS 201-1P6-1) or fan (other ACS 201 types).

The maximum ambient operating temperature allowed is 50 °C for constant torque drives when the load current is lower than or equal to the continuous maximum load current  $I_N$  and switching frequency is lower than or equal to 8 kHz. 110 %  $I_N$  continuous load is allowed when the ambient temperature is lower than or equal to 40 °C and switching frequency is lower than or equal to 8 kHz. The maximum ambient operating temperature allowed for specified overload capacity is 40 °C, when the load current is less than 150 % of  $I_N$  (120 % of  $I_N$  for ACS 201-4P1-1) lasting at most one minute in every ten minutes. See figure 2-1 below for power derating curves.

The cooling air must be clean and free from corrosive materials. If the cooling air contains dust, clean the cooling surfaces of the unit regularly using compressed air and a brush.

ACS 200 frequency converters are to be used in a heated, indoor, controlled environment that is relatively free of moisture and conductive contaminants such as condensation, carbon dust and the like.

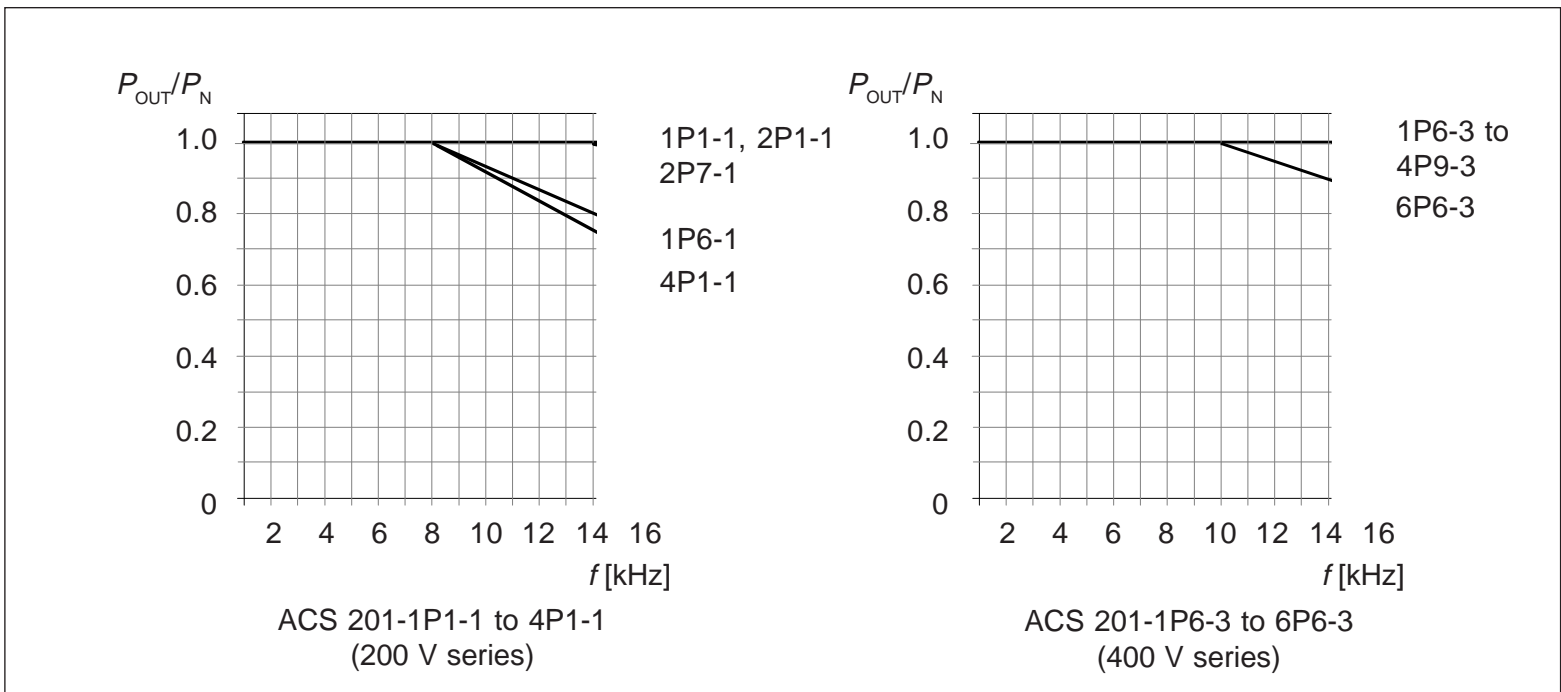

Figure 2-1. Power derating curves by switching frequency.

If multiple units are installed adjacent to or above each other, the following minimum distances apply:

- units side by side, clearance 12 mm
- units above each other, clearance 300 mm

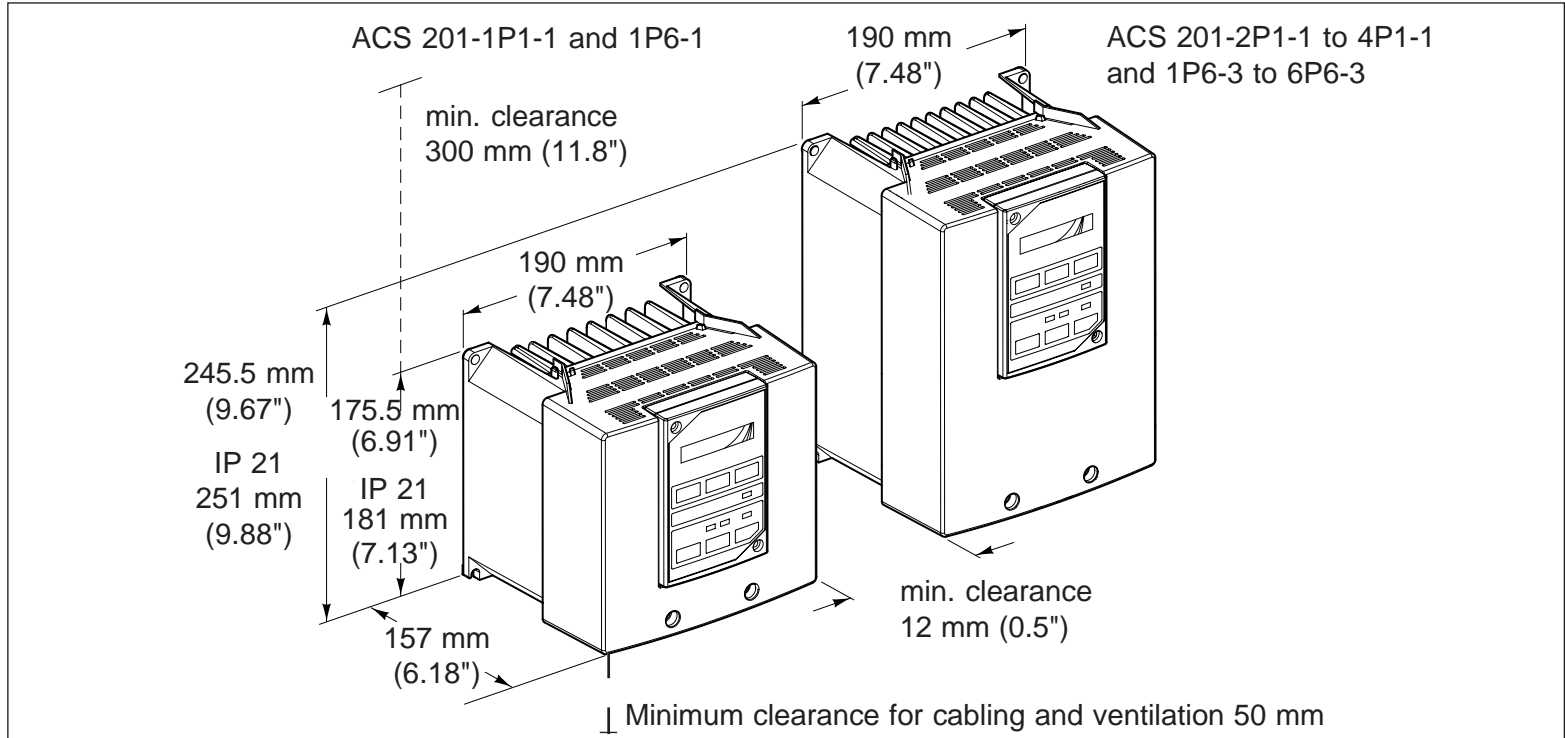

Figure 2-2. Space requirement for adequate cooling.

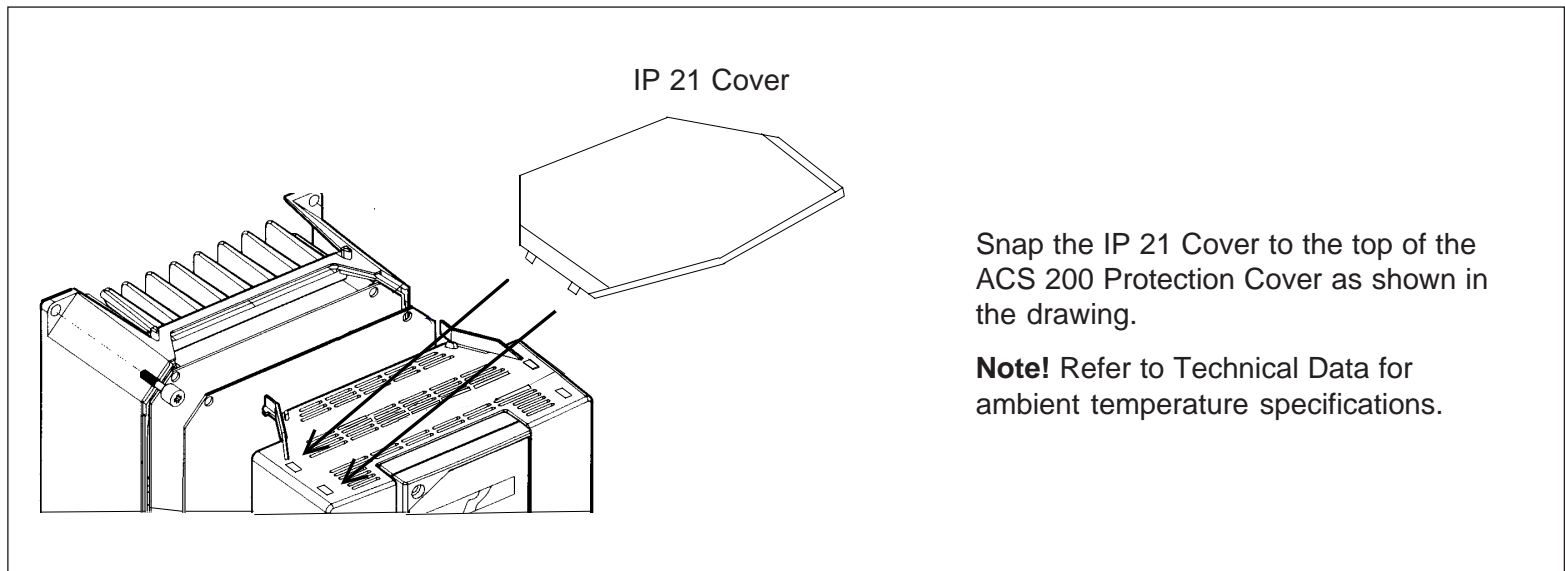

Figure 2-3. Installation of the IP 21 top cover.

# Mounting

## Mounting the ACS 200

To ensure proper cooling and safe installation, check that the mounting surface is relatively flat and that there are no openings allowing entrance to the back of the unit. The maximum size of the fixing screws for ACS 200 units is M6 (1/4").

Attach the ACS 200 by the fixing screws according to figure 2-4 below.

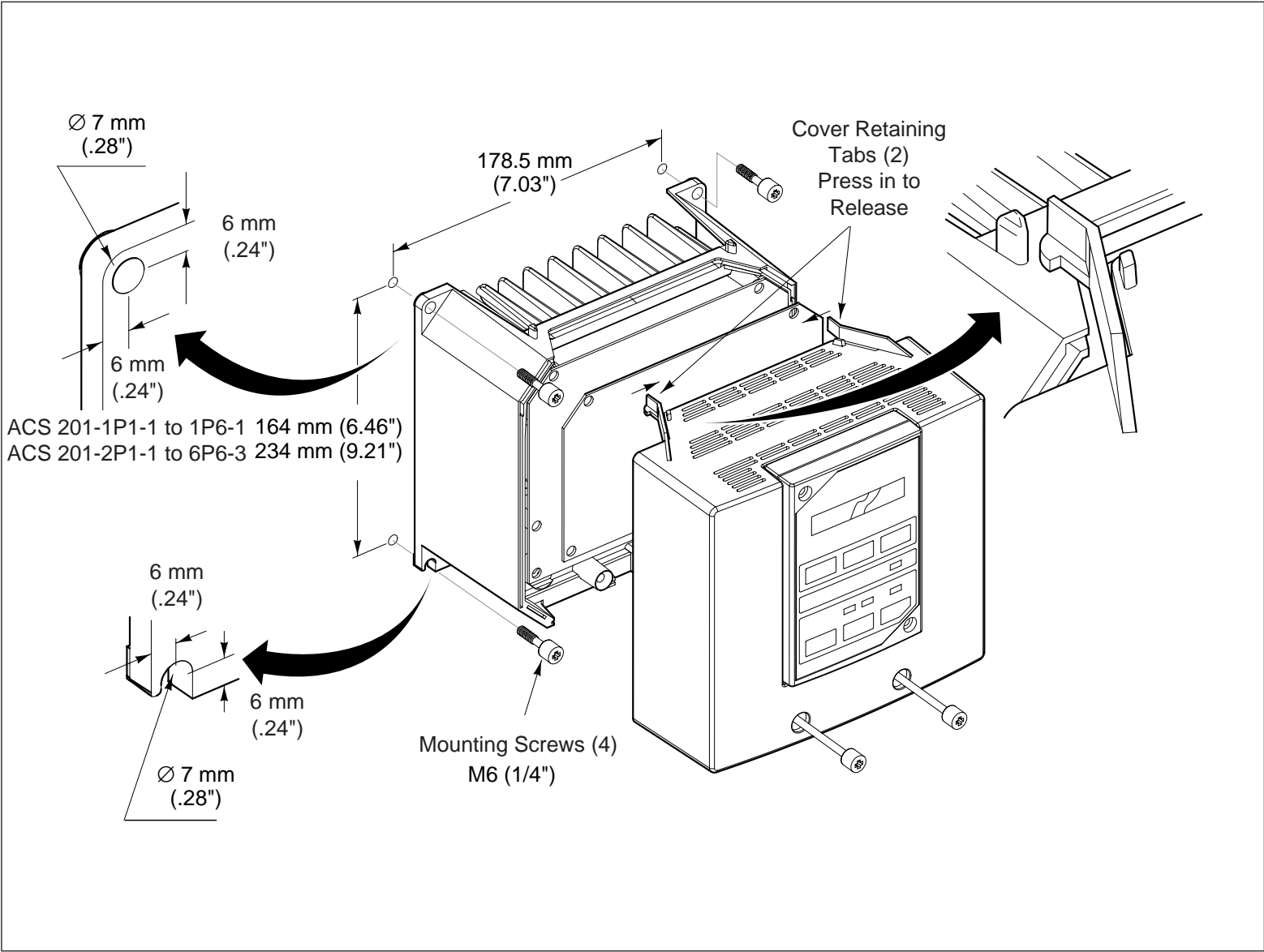

Figure 2-4. ACS 200 assembly.

**Mounting the Control Panel**

The Control Panel can be detached from the frequency converter and installed with a separate optional connection cable (approximately 3 m long) to the cabinet door for example. When installed correctly on a flat surface, with proper cable entry and sealing (option), the panel provides IP 65 (NEMA 4) enclosure class (IP 30 as loose item).

**Note!** The indication lights of the optional panel replacement cover are only functional when the cover is mounted on the drive.

**Note!** The optional panel replacement cover cannot be mounted on the ACS 200 when the Control Panel connection cable is connected.

1. Fit the IP 65 Sealing in the groove in the back of the Control Panel.
2. Plug the Connection Cable into the Control Panel.
3. Fit the Control Panel to the wall with the two screws.
4. Route the Connection Cable to the ACS 200 and connect.

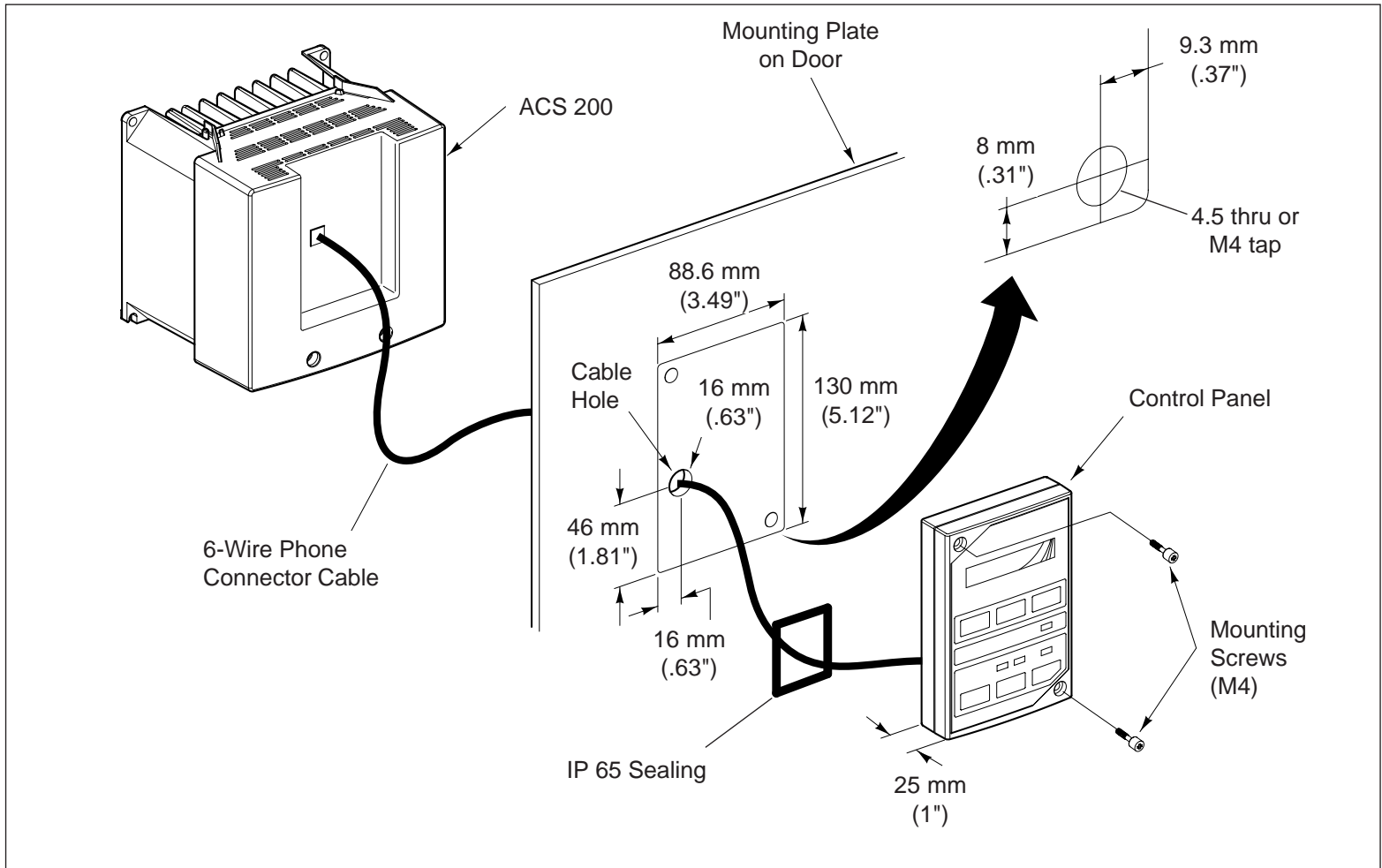

Figure 2-5. Control Panel mounting.

## 3 Power Connections

---

The ACS 200 is designed for use on 208 to 240 V single-phase supplies (ACS 201-2P1-1 to 4P1-1 can be used on a single-phase or a three-phase supply) and on 380 to 480 V three-phase supplies (ACS 201-1P6-3 to 6P6-3).

---



**Warning!** Do not under any circumstances connect three-phase, 380 V (or higher) voltage to the mains input terminals of the 208 to 240 V ACS 200.

---

**Note!** The factory setting of the 400 V series ACS 200 supply voltage (par. SUPPLY VOLT) is 480 V. If your supply voltage is much lower than 480 V (380 V, 400 V) you may get an undervoltage fault when first using the ACS 200. After connecting the mains cabling, change the value to correspond to the mains voltage. Press  to reset the fault.

---

### Mains cable

A three-conductor screened cable (single-phase with Protective Earth) or four-conductor (three-phase with Protective Earth) are recommended for the mains cabling. The cables and fuses are to be dimensioned in accordance with the output current. Refer to table 3-1 for minimum dimensions. When dimensioning cables and fuses, always pay attention to local authority regulations.

All mains connections shall be rated for 60 °C (140 °F) for use in ambient temperatures up to 45 °C (113 °F) or 75 °C (168 °F) for use in ambient temperatures up to 50 °C (122 °F). All mains connections shall be torqued to 1 Nm (8.8 in. lbs.).

### Motor cable

A four-conductor screened cable (three-phase with Protective Earth) is recommended due to the rapid voltage changes occurring in variable frequency motor drive systems.

---

**Note!** To avoid disturbances, install the motor cable away from other cable routes. Avoid long parallel runs with other cables.

---

The rapid voltage changes cause capacitive current between the phase conductors and the cable screen. This current increases with the switching frequency and motor cable length. This phenomenon can cause substantially higher current measured by the ACS 200 than the actual motor current, and can cause overcurrent tripping. Cable lengths of 100 m should not be exceeded.

Table 3-1. Mains &amp; motor cables and fuse recommendations.

Type designation <b>208 - 240 V</b>	Rated input current		Maximum permissible rated motor power		Recommended input fuse Fuse size [A] 250 V			Recommended mains and motor cable [mm <sup>2</sup> ]	
	$I_1$ [A]		$P_N$ [kW]	$P_N$ [hp]	1 phase	3 phase	Bussman type <sup>1)</sup>	1 phase	3 phase
	1 phase	3 phase							
ACS 201-1P1-1	6.6	-	0.55	0.75	10	-	FWX10A	2*1.5+1.5	-
ACS 201-1P6-1	8.9	-	0.75	1.0	10	-	FWX15A	2*1.5+1.5	-
ACS 201-2P1-1	12.2	8.4	1.1	1.5	16	10	FWX20A FWX15A	2*2.5+2.5	3*1.5+1.5
ACS 201-2P7-1	15.7	9.8	1.5	2.0	16	10	FWX20A FWX15A	2*2.5+2.5	3*1.5+1.5
ACS 201-4P1-1	22.4	12.9	2.2	3.0	32	16	FWX30A FWX20A	2*6.0+6.0	3*2.5+2.5

Type designation <b>380 - 480 V</b>	Rated input current		Maximum permissible rated motor power		Recommended input fuse Fuse size [A] 500 V		Recommended mains and motor cable [mm <sup>2</sup> ]
	$I_1$ [A]		$P_N$ [kW]	$P_N$ [hp]	3 phase	Bussman type <sup>1)</sup>	
	3 phase						
ACS 201-1P6-3	3.0		0.75	1.0	10	FWH10A	3*1.5+1.5
ACS 201-2P1-3	3.9		1.1	1.5	10	FWH10A	3*1.5+1.5
ACS 201-2P7-3	5.0		1.5	2.0	10	FWH10A	3*1.5+1.5
ACS 201-4P1-3	7.5		2.2	3.0	16	FWH15A	3*2.5+2.5
ACS 201-4P9-3	9.1		3.0	5.0	16	FWH15A	3*2.5+2.5
ACS 201-6P6-3	12.1		4.0	7.5	20	FWH20A	3*4.0+4.0

<sup>1)</sup> For systems requiring UL recognition.

## Insulation checks



**Warning!** Insulation checks are to be done before connecting the ACS 200 to the mains. Before proceeding with the insulation resistance measurements, make sure that the ACS 200 is disconnected from the mains. Failure to disconnect the mains could result in death or serious injury.

1. Check that the motor cable is disconnected from the ACS 200 output on terminals U2, V2 and W2.
2. Check that the motor cable is disconnected from the motor and remove bridging connections at the motor.
3. Measure the insulation resistances from the motor. The voltage range of the insulation resistance meter must be at least equal to the supply voltage, but not exceeding 1000 V. The insulation resistance must be greater than 1 MΩ.



4. Measure the insulation resistance of the motor cable between the phases and between each phase and Protective Earth. The insulation resistance must be greater than 1 MΩ.

## Terminal connections

To connect the mains, motor and control cables, remove the front cover of the unit by loosening the two screws at the bottom of the cover and pressing the tabs inward (see figure 2-4 on page 11).

The TEMP LIM parameter provides motor thermal protection. If this feature is not used, the motor connected to the ACS 200 requires overload protection in accordance with the National Electric Code (U.S.A.).

The ACS 200 has been short circuit tested in accordance with UL 508.

The frequency converter is suitable for use on a circuit capable of delivering not more than 5000 rms symmetrical amperes, 240 volts to 480 volts maximum, for the 208 - 240 volt or 380 - 480 volt units respectively.

Open the knock out holes in the lead-in insulator and fit standard conductor fittings.

Connect the mains and motor cables according to the layout in figure 3-1, page 15.



**Warning!** The braking resistor terminals carry a dangerous d.c. voltage. Only a recommended braking resistor should be connected to the Main Circuit Card, terminal block X5.

**Note!** If the motor cable has a separate screen in addition to the earth wire, the screen is connected to the PE terminal at the frequency converter end and to the motor earth inside the motor terminal box.

Unless you proceed with the control cable connections, attach the front cover of the unit with the two screws.

## Earthing and earth faults

The ACS 200 must always be earthed through an earthing conductor connected to the earthing terminal (PE).

If the ACS 200 is connected to a system without system earth, the earth fault protection must be capable of starting at earth fault currents containing high frequency and d.c. components. The ACS 200 earth fault protection guards only the frequency converter itself against earth faults occurring in the motor or the motor cable. It is NOT designed to protect personnel if they come in contact with the motor cable.

Fault current protective switches do not necessarily operate properly with frequency converters. When using such switches, check their function at possible earth fault currents arising in the fault situation.

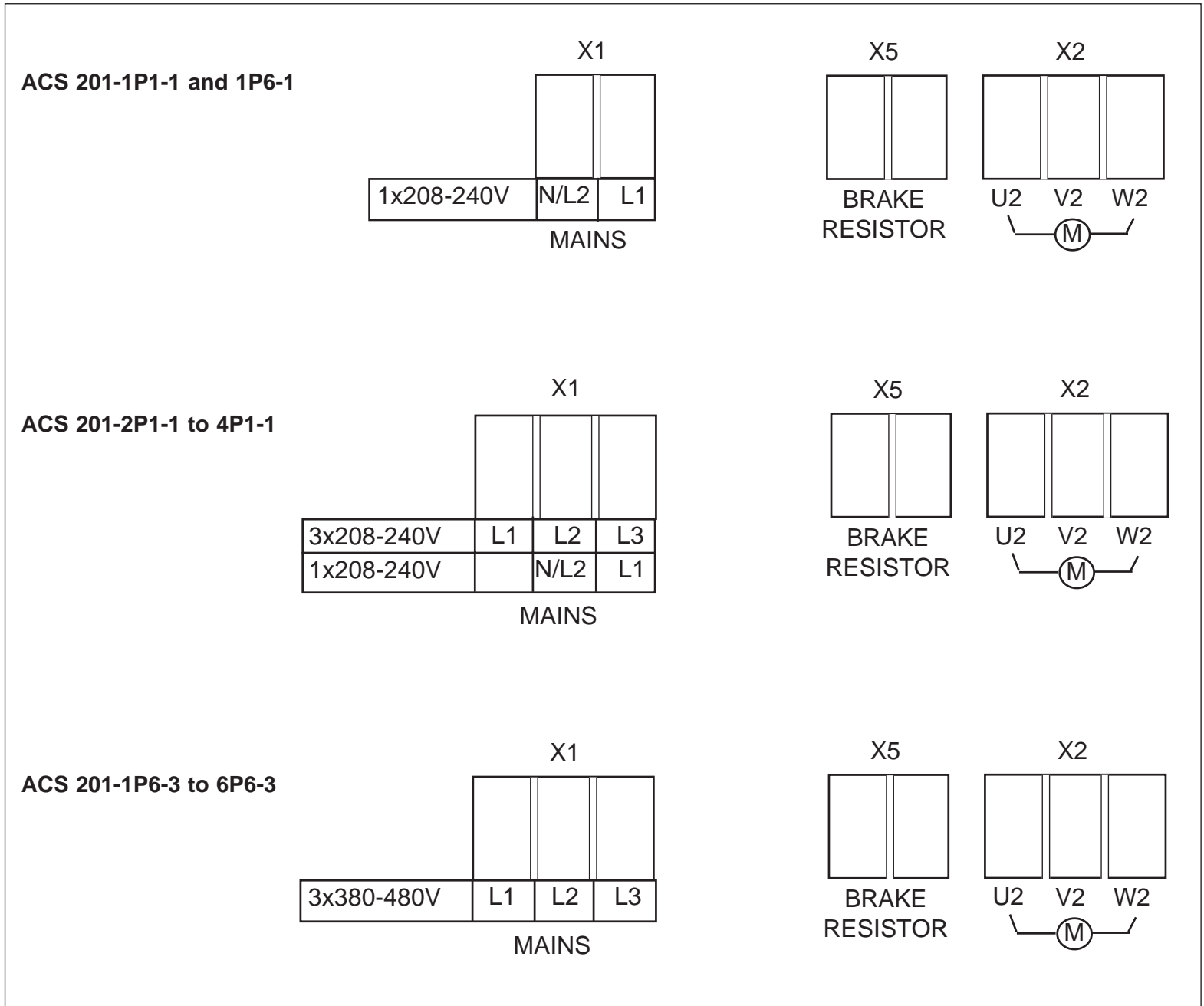

Figure 3-1. Mains and motor cable connections.



**Note!** The maximum permissible number of chargings per minute is four. Therefore in applications where frequent sequential Start/Stops are required electronic Start/Stop should be used, while the frequency converter is powered continuously.

## 4 Control Connections

The ACS 200 can be controlled by the ACS 200 Control Panel or by external control signals connected to the terminal block X1 of the Control Card.

### Control cables

Control cables for the ACS 200 should be 0.5 to 1.0 mm<sup>2</sup> screened, multi-core cables.

- The screens of the cables should be earthed at the frequency converter.
- Unscreened cables can be used for cable routes under 20 metres long.
- When planning the cabling between ACS 200 and an automation device, such as a PLC, attention should be given to interference suppression, signal levels, galvanic isolation, etc.

**Note!** The control connections of ACS 200 are galvanically isolated from the mains but not from the frame earth.

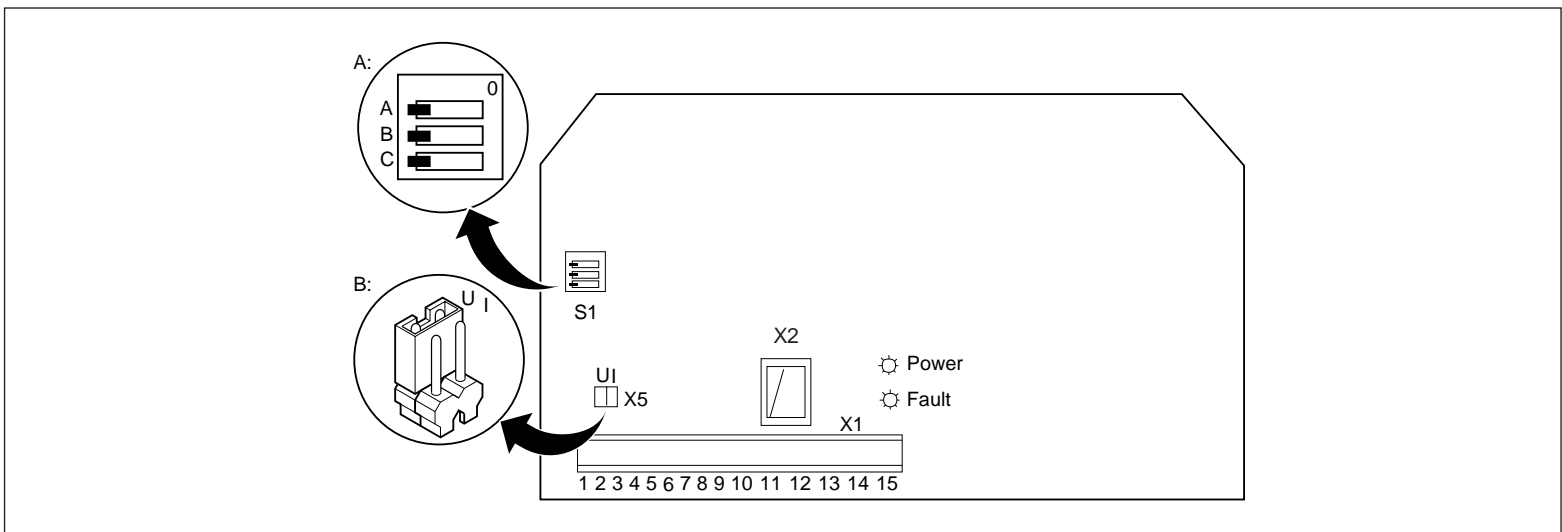

Figure 4-1. Control Card.

The analogue input signal selection is done with jumper X5 as shown in figure 4-1B:  $I$  = current 0(4) to 20 mA and  $U$  = voltage 0(2) to 10 V.

X1 = Terminal block for control connections.

X2 = Plug connection to Control Panel.

S1 = I/O option switch for control mode selection.

Figure 4-2. Control Card connections.

Terminal block X1		Function
1	REF	Reference for potentiometer +10 V d.c., maximum permitted burden 10 mA, $1\text{k}\Omega \leq R \leq 10\text{k}\Omega$
2	GND	
3	AI+	Analogue input, reference 0 to 10 V (or 0 to 20 mA) <sup>1)</sup> or 2 to 10 V (or 4 to 20 mA), $R_i = 200\text{k}\Omega$ (voltage signal) & $R_i = 250\ \Omega$ (current signal)
4	GND	
5	+24 V	Auxiliary voltage output +24 V d.c., max. permitted burden 100 mA
6	DI1	Digital inputs 1 - 5 Digital input functions are selected by Input/Output option switch S1, refer to page 19 for more detailed description.
7	DI2	
8	DI3	
9	DI4	
10	DI5	
11	AO+	Analogue output, signal 0 to 20 mA or 4 to 20 mA (minimum selected by Page 2 parameter A. OUT OFFS), $R_L \leq 500\ \Omega$
12	GND	
13	RO1	Relay output, general fault indication
14	RO2	
15	RO3	

<sup>1)</sup> Refer to figure 4-1 on page 17 for voltage/current reference selection.

**Relay output**

Relay output (Form C) on terminals X1:13, X1:14 and X1:15.

Continuity between terminals X1:13 and X1:14 indicates fault. If the ACS 200 is not connected to the mains, the fault relay indicates a fault. Continuity between terminals X1:14 and X1:15 indicates normal operation.

Maximum switching voltage: 300 V d.c./ 250 V a.c.

Maximum switching current: 8 A/ 24 V to 0.4 A/ 250 V d.c.

Maximum switching power: 2000 VA/250 V a.c.

Maximum continuous current: 2 A rms

**Input/output option selection**

I/O option switch S1 on the Control Card (See figure 4-1 on page 17) is used to configure the digital inputs and the Control Panel lock-out. The ACS 200 control input can be configured for four different wired control modes with S1,A and S1,B:

- Standard (refer to figure 4-3 page 19 and tables 4-1 to 4-2 page 19)
- 3-wire (refer to figure 4-4 page 20 and tables 4-3 to 4-4 page 20)
- Alternate (refer to figure 4-5 page 21 and tables 4-5 to 4-7 page 21)
- Motor Potentiometer (refer to figure 4-6 and table 4-8 page 22)

**Note!** The factory setting is Standard.

Switch S1,C is used to lock the Control Panel. If S1,C is in the OFF (0) position, parameter programming can be changed and the control place can be switched to local (panel control). If S1,C is in the ON (1) position, the Control Panel is locked and parameter programming cannot be changed, but can be examined. When locked, panel control is not allowed and "HARDWARE LOCK S1" message appears on the Control Panel display if you try to use the panel keys.

**Standard** The ACS 200 comes from the factory preset to Standard. Table 4-1 shows the functions of the digital inputs in Standard mode.

*Table 4-1. Standard digital input functions.*

Digital input	Function	Notes
DI1	Start	Connect +24 V DC to Start
DI2	Reverse	Connect +24 V DC to Reverse
DI3	CS1	Constant speed selection, refer to table 4-2
DI4	CS2	
DI5	ACC2/DEC2	0 V = ramp 1 and +24 V DC = ramp 2

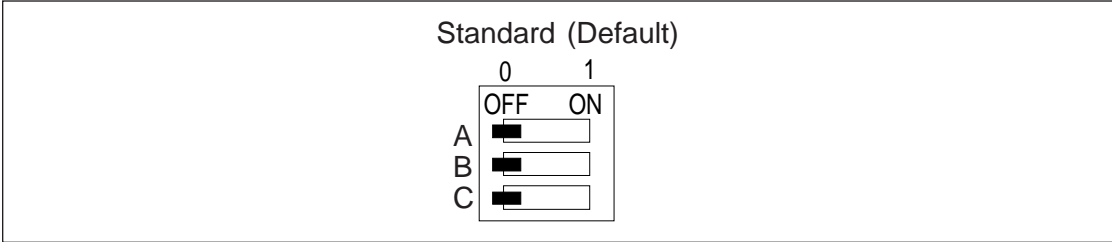

*Figure 4-3. Standard switch S1 selection.*

*Table 4-2. Constant speed selection.*

DI3	DI4	Result
0	0	Speed reference from AI1
+24 V	0	Constant speed 1
0	+24 V	Constant speed 2
+24 V	+24 V	Constant speed 3

**3-Wire** 3-Wire is for general industrial applications which usually require a three wire start/stop signal for safety reasons. With 3-wire control, momentary start and stop push-buttons are used. The Start button is normally open, and the Stop button is normally closed. When operating from external momentary push-buttons, the ACS 200 requires a start command to be given after power is applied.

The stop input is active even when operating from the keypad, allowing the normally closed contact from a motor overload relay or other external interlock to stop the frequency converter when operating from the keypad. A connection must exist between X1:5 and X1:7 for the frequency converter to operate.

Table 4-3. 3-Wire digital input functions.

Digital input	Function	Notes
DI1	Start <sup>1)</sup>	Connect momentary +24 V DC to Start
DI2	Stop <sup>2)</sup>	Connect momentary 0 V DC to Stop
DI3	Reverse	Connect +24 V DC to reverse
DI4	CS1	Constant speed selection, refer to table 4-4.
DI5	CS2	

- 1) Minimum Start pulse is 50 ms. Stop must be connected to +24 V for Start to function.
- 2) Minimum Stop pulse is 50 ms. If Start is active (+24 V), ACS 200 will restart after Stop pulse is connected to +24 V.

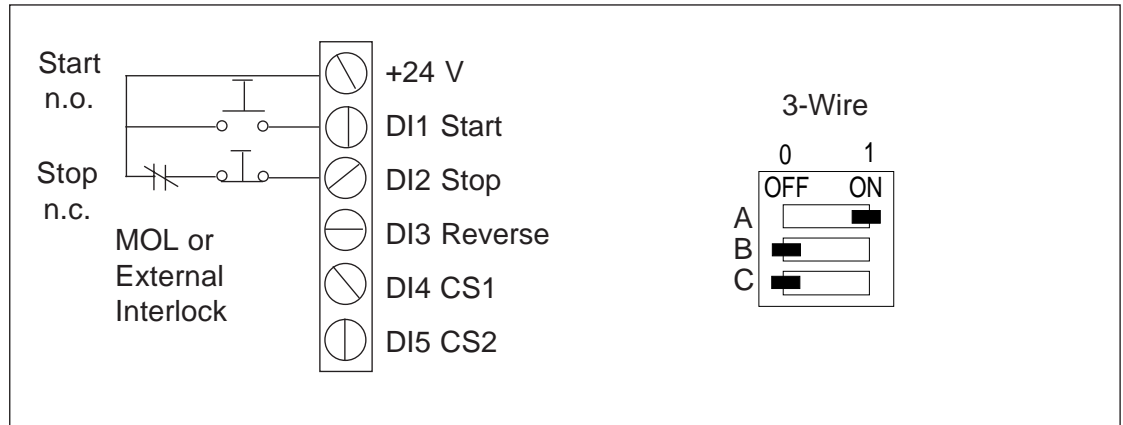

Figure 4-4. 3-Wire recommended cabling and switch S1 selection.

Table 4-4. Constant speed selection.

DI4	DI5	Result
0	0	Speed reference from AI1
+24 V	0	Constant speed 1
0	+24 V	Constant speed 2
+24 V	+24 V	Constant speed 3

**Alternate** Alternate mode has both Start forward and Start reverse inputs (+24 V). The drive is stopped if both inputs are connected to 0 V or +24 V.

Table 4-5. Alternate digital input functions.

Digital input	Function	Notes
DI1	Start Forward	Connect +24 V DC to Start forward (table 4-6)
DI2	Start Reverse	Connect +24 V DC to Start reverse (table 4-6)
DI3	CS1	Constant speed selection, refer to table 4-7
DI4	CS2	
DI5	ACC2/DEC2	0 V = ramp 1 and +24 V DC = ramp 2

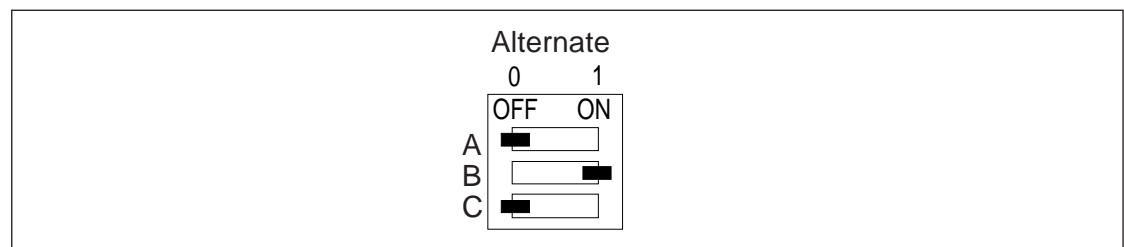

Figure 4-5. Alternate switch S1 selection.

Table 4-6. Start functions for Alternate.

DI1	DI2	Result
0	0	Drive stopped
+24 V	0	Run forward
0	+24 V	Run reverse
+24 V	+24 V	Drive stopped

Table 4-7. Constant speed selection.

DI3	DI4	Result
0	0	Speed reference from AI1
+24 V	0	Constant speed 1
0	+24 V	Constant speed 2
+24 V	+24 V	Constant speed 3

**Motor Potentiometer**

Motor Potentiometer mode has motor potentiometer function programmed to digital inputs 3 and 4. Table 4-8 shows the functions of the digital inputs when in Motor Potentiometer mode.

*Table 4-8. Motor Potentiometer digital input functions.*

Digital input	Function	Notes
DI1	Start	Connect +24 V DC to Start
DI2	Reverse	Connect +24 V DC to Reverse
DI3	Increment fr.	Connect +24 V DC to increment freq. (ramp 2)
DI4	Decrement fr.	Connect +24 V DC to decrement freq. (ramp 2)
DI5	CS1	Connect +24 V DC to select constant speed 1

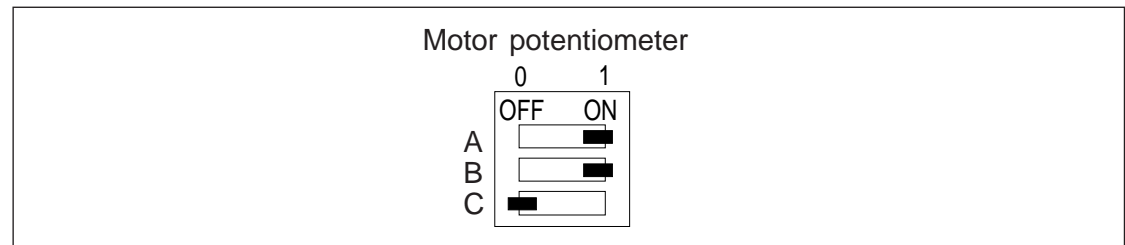

*Figure 4-6. Motor Potentiometer switch S1 selection.*



# 5 Control and Parameter Logic

## Control Panel

The control panel incorporates a 16 character alphanumeric LCD and keypad. The features are shown in figure 5-1 below.

### Control panel display

Operational information, parameters and fault indications are displayed in nine languages as well as a code system. Language selections are: English, Finnish, Swedish, German, Italian, French, Spanish, Dutch and Danish (and Code). The language selection is made in Page 1 parameter LANGUAGE (refer to chapter 7, page 29).

### Display contrast

To adjust the display contrast, hold down **\*** and press **↑** for darker or **↓** for lighter characters.

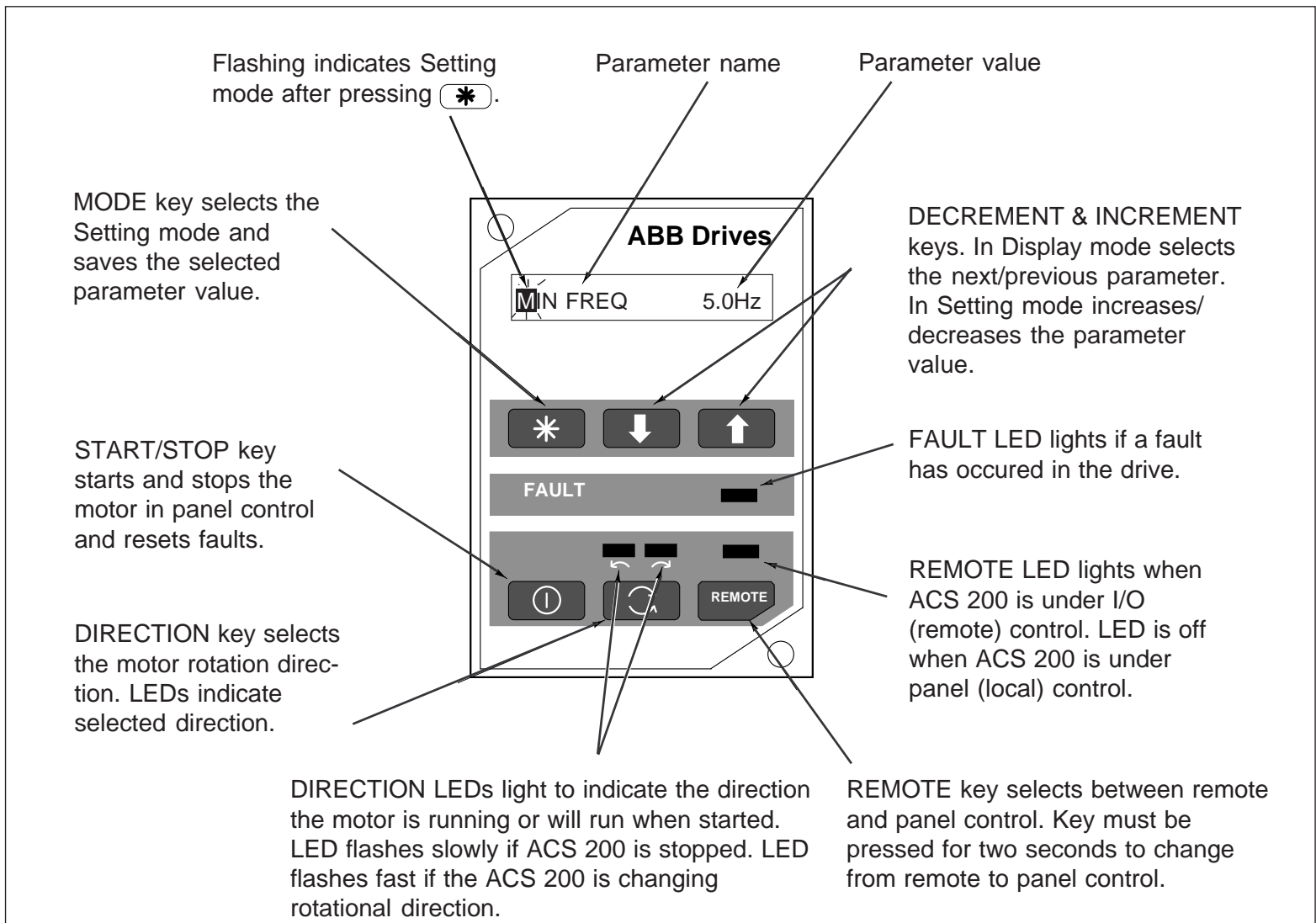



Figure 5-1. ACS 200 Control Panel.

## Panel operation

The ACS 200 frequency converter can be operated from external controls or directly from the control panel. The first time the ACS 200 is connected to the mains, the default control place is Remote (refer to Remote in this section for a description). You can change the control place to Local (panel control) by pressing and holding the  key down for two seconds. The associated LED will turn off indicating that the ACS 200 is not under remote control.





















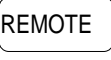
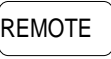

- Remote** When the  key is pressed, the associated light will turn on indicating that the ACS 200 is under remote control. The ACS 200 is then controlled from the devices connected to the terminal block X1 on the Control Card.
- Local** Operation can be changed from Remote to Local in two ways, as described below. The first method allows you to transfer running information from external devices to the control panel while the ACS 200 is operating and without interrupting operation.
- Press and hold the  key and the  key simultaneously for two seconds. This will transfer the current external reference to Page 1 parameter REF FREQ/LOC FREQ. For example, if the drive is running in reverse at 45.7 Hz reference from the analogue input, the panel frequency reference will now be 45.7 Hz; the panel direction will be reverse; and the panel run status will be run. The operator can now change the frequency, direction and run status of the drive from the control panel.
- If only the  key is pressed, the motor stops and the analogue input reference value REF FREQ is transferred to LOC FREQ (**Note!** Constant speed reference is also transferred). The motor can be started from the control panel within the limits established by parameter settings.
- Home** Press and hold the  key and the  key simultaneously for three seconds to move to the OUTPUT f parameter from any parameter location.

Table 5-1. Control panel keys.

Control Panel key	Secondary key	Function
		Press to change between Display mode and Setting mode.
	 	Hold down to set the display contrast and: Press to adjust characters lighter or Press to adjust characters darker.
		Press and hold for two seconds to change between remote control and local control. Refer to section Panel operation on page 23 for an explanation. <b>Note!</b> Hardware panel lock prevents local control. Message if key is pressed: "HARDWARE LOCK S1".
		Hold down to select the Local control mode: Transfers the running data to local control (current speed/direction/start).
		Press to start or stop the drive or Press to reset an active fault (fault is active when the fault LED is illuminated).
		Press to set motor rotation direction. <b>Note!</b> This procedure reverses the motor only when the drive is running in Local control mode. Refer to section Local on page 23 for additional information.
		Hold down to scroll up in Display and Setting modes.
		Hold down to scroll down in Display and Setting modes.
		Press to change up to the next parameter in Display mode or Press to increment the current parameter value in Setting mode.
		Press to change down to the next parameter in Display mode or Press to decrement the current parameter value in Setting mode.
		Press and hold both keys simultaneously for three seconds to move directly to the OUTPUT f parameter.
		Remote light indicates the ACS 200 is under remote control.
		Direction light indicates the current motor rotation direction. When the direction light flashes slowly, the ACS 200 is in Stop status. When the direction light flashes fast, the ACS 200 is changing rotational direction.

## Parameter logic

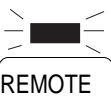
The parameters are divided into two pages. A complete table of parameters is presented in chapter 7, Drive parameters page 30.

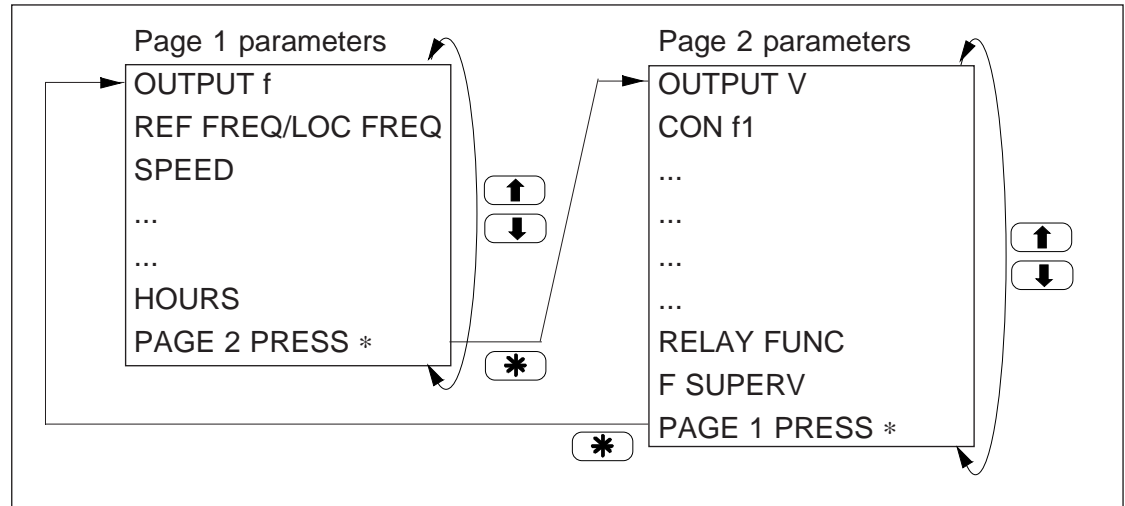

Figure 5-2. Menu system of parameters.

Figure 5-3. Example of Control Panel operation. Let us suppose that you want to set Page 2 parameter CON f1 to 15 Hz. The following example explains the procedure required starting from the Page 1 parameter SPEED.

SPEED 0



PAGE2PRESS \*



OUTPUT V 0.0V



CONf1 5.0Hz



CONf1 5.0Hz



CONf1 15.0Hz



CONf1 15.0Hz

To change to Page 2, select parameter PAGE 2 and press .

Select the required parameter by pressing the key.

Change to Setting mode.

Flashing indicates that the parameter value can now be changed.

Set the parameter value.

Save the selected value to permanent memory.

Flashing stops indicating that the parameter value is stored in memory.

**Note!** To accelerate the change of parameter value, keep the or key depressed continuously.

## 6 Commissioning

### Safety precautions

Before commissioning, observe the following warnings.



**Warning!** The Main Circuit Card (bottom card) and parts of the Control Card (upper card) are at mains potential when the ACS 200 is connected to the mains. This voltage is extremely dangerous and can cause death or severe injury if you come in contact with it. When the supply voltages are disconnected from the terminal block X1, it will take about five minutes before the capacitors in the intermediate d.c. circuit are discharged to a safe voltage.

The "DANGER" (or "CHARGE") LED on the bottom left corner of the Main Circuit Card will light when the potential in the frequency converter is unsafe. If the cover has been removed and the "DANGER" (or "CHARGE") LED is on, verify that the frequency converter has been disconnected from the mains and wait for the "DANGER" (or "CHARGE") LED to turn off. Even after the "DANGER" ("or CHARGE") LED has turned off, there can be some residual charge in the d.c. link capacitors, that can damage the electronics if accidentally conducted to the Control Card. This is why you have to wait 5 minutes before servicing the unit.

To ensure that the voltage level is safe, measure the mains input on Main Circuit Card terminal block X1.

Dangerous external control voltages may be present on the relay output of the Control Card. Always check for high voltage at X1 terminals 13-15, if they are switching supply voltage.



**Warning!** When the ACS 200 is connected to the mains, the motor terminals U2, V2 and W2 are live even if the motor is not running. Do not make any connections when the ACS 200 is connected to the mains. Disconnect and lock out mains to the frequency converter before servicing the unit. Failure to disconnect mains may cause death or serious injury.

### Commissioning checklist

#### Preparation

- |                         |  |
|-------------------------|--|
| Safety precautions      | • Read and follow the safety instructions.   |
| Installation inspection | • Check for proper earthing.<br>• Check supply and motor cables.<br>• Check control cables.<br>• Verify availability and quality of cooling air. |

#### Start-up

- |                      |   |
|----------------------|---|
| Parameter settings   | • Check and complete the parameter values.  |
| Keypad control tests | • Check the operation of the ACS 200 without motor.<br>• Check the operation of the ACS 200 with motor connected.<br>• Check external controls and emergency stop (if installed). |

## Installation inspection

Inspect the mechanical and electrical installation of the ACS 200 for compliance with the local electrical installation regulations and the installation instructions contained in chapters 2 - 4.

**Note!** Do not connect the motor cable before proceeding with the Keypad control test without motor. Refer to text below.

After installation, inspect the following:

- Protective Earthing of the ACS 200 and the motor.
- Supply and motor cables (selection of the cable size, connections, fuse protection, cable screen earthing).
- Control cables (connections, cable screen earthing, location as far as possible from the the power cables).
- Quantity and quality of cooling air for the ACS 200.
- Check that on/off switches of external controls (if exist) are set to off. Make sure that it is safe to run the motor in either direction.
- Connect the ACS 200 to the mains. Check by measuring that the voltage between L1-L2, L2-L3 and L1-L3 is  $U_N \pm 10\%$  (if single phase supply, L1-N is  $U_N \pm 10\%$ ).

## Checking the parameters

The ACS 200 is delivered with the parameters set to the factory settings. If it is necessary to adjust the parameter values, refer to the instructions in chapter 7 Drive Parameters page 30. Use the parameter tables on pages 30-31 to write down your customised settings.

### Start-up data

Before proceeding with the commissioning, check and complete the following Page 1 parameters which define the motor connected to the ACS 200 and mains supply (400 V series only):

NOM RPM = Nominal motor speed

NOM FREQ = Nominal motor frequency

(**Note!** If NOM FREQ is set to 60 Hz,  $f_{MAX}$  also changes to 60 Hz)

NOM VOLT = Nominal motor voltage

COS PHI = Cos phi of the motor

SUPPLY VOLT = Supply voltage (400 V series only)







## Keypad control tests

### Motor disconnected from the ACS 200

1. Disconnect the ACS 200 from the mains.

**Note!** Wait at least five minutes after the display readout has disappeared before taking any further action within the frequency converter. Verify that the "DANGER" (or "CHARGE") LED on the bottom left corner of the Main Circuit Card is off before working within the ACS 200.

2. If the motor is connected to the ACS 200, disconnect it.
3. Connect the ACS 200 to the mains and switch power on.
4. Press and hold the  key for two seconds to select Panel control mode.



5. Select Page 1 parameter REF FREQ/LOC FREQ. Press  to go to Setting mode. Use the  key to increase the reference to 10 Hz.
6. Give a Start command by pushing . The run status is indicated by the continuously lit rotation direction LED. Slow flashing indicates Stop status.
7. Use the  key to change the rotational direction. Verify that the rotational direction changes. Fast flashing LED indicates change status.
8. Control the reference frequency with the  and  keys.
9. Press  to return to Display mode. Check the following parameters:
  - OUTPUT I - should be less than 1 A.
  - OUTPUT V - should increase with the frequency. Nominal voltage is reached at the nominal motor frequency.
10. If everything is operating normally, turn off the ACS 200 by disconnecting it from the mains.

For fault tracing information, refer to chapter 8 Fault Tracing, page 44.

#### Motor connected to the ACS 200





1. Disconnect the ACS 200 from the mains.

**Note!** Wait at least five minutes after the display readout has disappeared before taking any further action within the frequency converter. Verify that the "DANGER" (or "CHARGE") LED on the bottom left corner of the Main Circuit Card is off before working within the ACS 200.

2. Connect the motor to the ACS 200.
3. Connect the ACS 200 to the mains and switch power on.
4. Press and hold the  key for two seconds to select Panel control mode.
5. Select Page 1 parameter REF FREQ/LOC FREQ. Press  to go to Setting mode. Use the  key to increase the reference to 0.5 Hz.



**Warning!** If rotational direction is critical, do not increase speed reference after start more than necessary to make sure the motor is running in the right direction. If the rotational direction is not correct, swap any two wires of the motor cable phase connections. The rotational direction can be locked to forward only by using the DIR parameter. See page 41.

6. Give a Start command by pushing .
7. Press  to return to Display mode.
8. Check the operating data parameter values for normal operation.
9. Select Page 1 parameter REF FREQ/LOC FREQ and press  to go to Setting mode.
10. Use the  key to increase the reference. Verify that the frequency is increasing. Increase the frequency to maximum process speed.
11. Test the functioning of the emergency stop (if installed).

# 7 Drive Parameters

Table 7-1. Drive parameters and their factory settings (Default). **Note!** The factory setting for display language is English (refer to Page 1 parameter LANGUAGE for display language selection). Parameters marked with (0) can only be altered with the ACS 200 stopped otherwise START IS ACTIVE message is displayed. (L) indicates that the parameter can be altered in Local control mode only.

## PAGE 1 parameters

Code	Parameter	Range	Default	Customer	Page	Description
101	OUTPUT f	Display only	-	-	32	Frequency to motor
102	REF FREQ/ LOC FREQ (L)	$f_{MIN}$ to $f_{MAX}$ ( $f_{MAX}$ to $f_{MIN}$ , if $f_{MIN} > f_{MAX}$ )	0.0 Hz		32	Frequency reference from remote or Control Panel
103	SPEED	Display only	-	-	32	Calculated motor speed
104	OUTPUT I	Display only	-	-	32	Motor current
105	COPY	Exit/Read/Write (0)/ Set Factory Def. (0)	Exit		32	Transfers all settings to and from control panel
106	MIN FREQ	0.0 to 200/500 Hz <sup>1)</sup>	0.0 Hz		32	Ref. input min. frequency
107	MAX FREQ	0.0 to 200/500 Hz <sup>1)</sup>	50.0 Hz		32	Ref. input max. frequency
108	ACC 1	0.1 to 1800 s	3.0 s		32	Time for $f_{MIN}$ to $f_{MAX}$ acceleration ramp
109	DEC 1	0.1 to 1800 s	3.0 s		32	Time for $f_{MAX}$ to $f_{MIN}$ deceleration ramp
110	ACC 2	0.1 to 1800 s	3.0 s		32	Time for $f_{MIN}$ to $f_{MAX}$ acceleration ramp
111	DEC 2	0.1 to 1800 s	3.0 s		32	Time for $f_{MAX}$ to $f_{MIN}$ deceleration ramp
112	FAULT MEMORY	Display only	-		33	The last 3 fault indications
113	NOM RPM (0)	0 to 19999	1500		33	Nominal motor speed
114	NOM FREQ (0)	50 to 400 Hz	50.0 Hz		33	Nominal motor frequency
115	NOM VOLT (0)	200 to 240 V or 360 to 480 V <sup>2)</sup>	220 V or 380 V <sup>2)</sup>		33	Nominal voltage of the motor
116	COS PHI (0)	0.40 to 0.99	0.75		33	Cos phi of the motor
117	SUPPLY VOLT <sup>2)</sup> (0)	380 to 480 V	480 V		33	Supply voltage selection
118	LANGUAGE	GB/FIN/S/D/I/ F/E/NL/DK/CO	English		33	Display language selection
119	TEMP MOD	Display only	-		34	Calculated motor temperature
120	HOURS	Display only	-		34	Operation timer
1-2	PAGE 2 PRESS *	-	-	-	34	Press  to go to Page 2

<sup>1)</sup> Depends on the selected nominal motor frequency (Page 1 parameter NOM FREQ). <sup>2)</sup> Only in 400 V series.

**Note!** ACC/DEC TIME is set below the maximum (1800 s) value, when MIN FREQ to MAX FREQ < 100 Hz.

**Note!** If NOM FREQ is set  $\geq$  60 Hz, NOM RPM changes to 1800 rpm and MAX FREQ to 180 Hz.



## PAGE 2 parameters

Code	Parameter	Range	Default	Customer	Page	Description
201	OUTPUT V	Display only	-	-	34	Output voltage to motor
202	CON f 1	0.0 to 200/500 Hz <sup>1)</sup>	5.0 Hz		34	Override frequency 1
203	CON f 2	0.0 to 200/500 Hz <sup>1)</sup>	25.0 Hz		34	Override frequency 2
204	CON f 3	0.0 to 200/500 Hz <sup>1)</sup>	50.0 Hz		34	Override frequency 3
205	I LIMIT	0.5 to 1.5 * I <sub>N</sub>	1.5 * I <sub>N</sub>		34	Output current limit
206	START (0)	Acc Ramp/Flying/ Auto Boost/Fly+Boost	Acc Ramp		34	Conditions during motor acceleration
207	STOP (0)	Coasting/Dec Ramp/ DC Brake/Dec+Brake	Coasting		35	Conditions during motor deceleration
208	RAMP (0)	Linear/Fast S/ Medium S/Slow S	Linear		35	Acceleration/deceleration ramp shape selection
209	REF OFFSET (0)	0V0mA/2V4mA/ Joystk/Custom	0V0mA		36	Analogue input minimum and type selection
210	A. OUT	None/Out Freq/ Ref Freq/Motor Cur	Out Freq		37	Analogue output content
211	A. OUT OFFS	0mA/4mA	0 mA		38	Analogue output zero value
212	SWITCH f	1.0 to 16.0 kHz	8.0 kHz		38	Modulation frequency
213	CRIT f1L	0.0 to 200/500 Hz <sup>1)</sup>	0.0 Hz		38	Critical frequency 1 start
214	CRIT f1H	0.0 to 200/500 Hz <sup>1)</sup>	0.0 Hz		38	Critical frequency 1 end
215	CRIT f2L	0.0 to 200/500 Hz <sup>1)</sup>	0.0 Hz		38	Critical frequency 2 start
216	CRIT f2H	0.0 to 200/500 Hz <sup>1)</sup>	0.0 Hz		38	Critical frequency 2 end
217	IR COMP	Off/0.1 to 60 V/Auto	Off		39	Low speed torque boost function
218	DC-BRAKE	1 to 250 s	3 s		40	Duration of d.c. braking
219	U/f RATIO (0)	Linear/Square/Optimum	Linear		40	U/f in region below field weakening point
220	RESTART #	Off/1 to 10/Cont	Off		40	Number of faults limit for Autoreset logic
221	TEMP LIM	Off/1 to 500 Hz	Off		41	Motor thermal protection
222	MOTOR I	0.5 to 1.5 * I <sub>N</sub>	I <sub>N</sub>		41	I <sub>NMOT</sub> for thermal protection
223	DIR	FWD/REV; FWD only	FWD/REV		41	Reverse lock-out
224	AI-FAULT	Enable/Disable	Enable		42	AI fault if AI < 2 V/4 mA
225	P.LOCK	Open/Locked	Open		42	Parameter lock
226	RELAY FUNC	1 - 11	-		42	Relay function selection
227	F SUPERV	Hz	-		42	Relay function outp. freq. limit
2-1	PAGE 1 PRESS *	-	-	-	42	Press  to go to Page 1

<sup>1)</sup> Depends on the selected nominal motor frequency (Page 1 parameter NOM FREQ).

## Page 1 parameters

OUTPUT f Frequency to motor. This parameter is display only. Jump directly to local frequency reference setting (par. LOC FREQ) by pressing .

REF FREQ/LOC FREQ The frequency reference input or local frequency reference.

SPEED Motor speed in rpm. The indicated value is valid only if parameter NOM RPM has been set correctly. Motor slip is not compensated. Information is updated four times per second.

OUTPUT I Calculated motor phase current. Accuracy  $\pm 10\%$ . Includes cable losses.  
**Note!** This display is not for accurate measurement.

COPY Can be used to transfer all parameter settings from one ACS 200 to another.

### EXIT

Copy function not selected.

### READ

Reads all parameter values from the ACS 200 to the control panel memory.

### WRITE

Copies all parameter values from the control panel memory to the ACS 200.

### SET FACTORY DEF

If you select SET FACTORY DEF and press the  key, all the parameters will be reset to the factory settings.

MIN FREQ Reference input minimum and maximum frequency.

MAX FREQ **Note!** MIN can be set higher than MAX for analogue input signal inverse operation.

ACC 1 These times correspond to the time required for the output frequency to change  
DEC 1 from MIN FREQ to MAX FREQ and vice versa. Regardless of the settings, the  
ACC 2 maximum theoretical acceleration/deceleration is 120 Hz/0.1 s and the minimum  
DEC 2 100 Hz/1800 s. The time required for the acceleration from zero to minimum fre-  
quency depends on ACC 1.

When the selected I/O mode is Standard or Alternate, digital input 5 selects between ACC/DEC 1 and 2. 0 V = ramp 1 and +24 V = ramp 2. Refer to page 19 for a detailed explanation of I/O modes.

**Note!** The ACS 200 incorporates a controller that prevents overcurrent and overvoltage trips, caused by too quick acceleration and deceleration settings for a given system, by slowing down the acceleration/deceleration.

If a short time is entered for acceleration time in a system with high inertia, the acceleration time will be limited by the I LIMIT parameter. Conversely, if a short time is entered for deceleration time in such a system, the deceleration time will be limited by the d.c. link bus regulator. In some cases, the motor will take a long time to come to a stop. If the system inertia is high, an OVERVOLTAGE fault may occur if the deceleration time is too small. The ACS 200 can deliver about 15 % dynamic braking torque without an external braking resistor. If a short deceleration time is

critical to your application, we suggest you add a dynamic braking resistor (option) to your system. The maximum (minimum) recommended acceleration (deceleration) for the nominal size motor is 40 Hz per second. If the motor rating is less than the nominal power of the ACS 200, smaller settings can be used.

If the reference signal changes at a slower rate than the acceleration or deceleration time, the output frequency change will follow the reference signal. If the reference signal changes faster than the acceleration or deceleration time, the output frequency change will be limited by the parameters.

**FAULT MEMORY** The ACS 200 continuously monitors itself for faulty operation. The last three faults are stored in Page 1 parameter FAULT MEMORY. Refer to chapter 8 Fault Tracing, page 44, for further information on fault memory.

**NOM RPM** Nominal motor rpm from the motor rating plate.

**NOM FREQ** Nominal motor frequency from the motor rating plate (sometimes called the field weakening point). The maximum output frequency of the ACS 200 is determined according to the nominal motor frequency:  
 50-100 Hz =>  $f_{MAX}=200$  Hz; 101-400 Hz =>  $f_{MAX}=500$  Hz

**NOM VOLT** Nominal motor voltage (from the motor rating plate). NOM VOLT sets the maximum output voltage supplied to the motor by the ACS 200. NOM FREQ sets the frequency where the voltage to the motor is equal to NOM VOLT. With these two parameters it is possible to adapt the ACS 200 to the motor.

ACS 200 cannot supply voltage to the motor greater than the mains voltage. When driving a motor that has a nominal voltage lower than the supply voltage, it may not be possible to drive the motor at full torque because of current limitations.

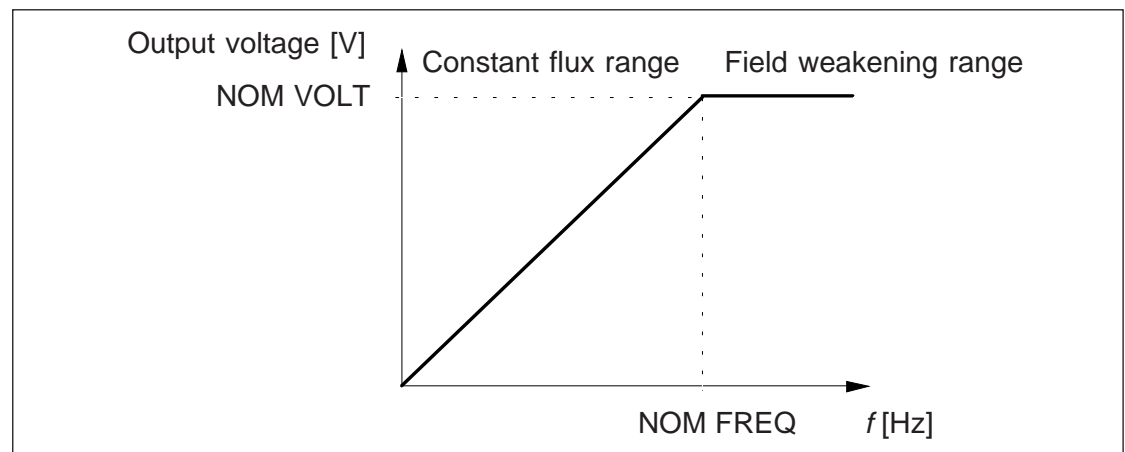



Figure 7-1. Parameters NOM FREQ and NOM VOLT determine the voltage to frequency ratio of the motor.

**COS PHI** Power factor (Cos phi) of the motor from the motor rating plate.

**SUPPLY VOLT** Mains supply voltage. This parameter exists only in the 400 V series units.  
**Note!** NOM VOLT can only be set within  $\pm 20$  V of SUPPLY VOLT.

**LANGUAGE** Select the preferred display language. (CO = code language)

TEMP MOD	Calculated temperature of the motor as a percentage (%)of nominal temperature. Motor temperature is calculated from the motor current. MOTOR TEMP fault occurs when TEMP MOD signal is equal to 115%.
HOURS	Operation timer shows in hours how long the drive has been running.
PAGE 2 PRESS *	Press  to change to Page 2.

## Page 2 parameters

OUTPUT V	The voltage applied to the motor. This parameter is display only.
CON f 1	Override frequency (preset speed) 1, 2 and/or 3. Constant frequencies override analogue input reference. Constant frequencies are activated with digital inputs 3 and 4 or digital inputs 4 and 5 depending on the I/O mode selected. For constant frequency selection, refer to I/O mode descriptions on pages 19 to 21.
CON f 2	
CON f 3	
I LIMIT	This setting is the maximum output current the ACS 200 will supply to the motor.
START (FUNCTION)	<b>ACC RAMP</b> Ramp acceleration as set in Page 1 par. ACC 1 (or ACC 2 as selected by digital inputs in Standard and Alternate I/O mode, refer to pages 19 to 21). <b>FLYING</b> Use this setting to start the motor if it may be already rotating, as in a fan drive. The drive will start smoothly at the current frequency instead of starting at 0 Hz. By selecting FLYING, the drive will be able to ride through short interruptions of the mains supply. <b>Note!</b> Flying start searches for the running speed by applying a small torque to the load at the maximum frequency and decreasing the output frequency until the load speed is found. If the motor is not coupled to a load or the load has low inertia, the motor will start at a speed higher than the set reference. <b>Note!</b> If the motor and load are rotating in a direction opposite to the commanded rotation, the ACS 200 will start the motor from 0 Hz and accelerate according to the selected acceleration ramp. <b>AUTO BOOST</b> Automatic start current boost, which may be necessary in drives with high starting torque. Automatic torque boost is active only from 0 Hz to 20 Hz or until the reference speed is reached. Torque boost is not activated if the output frequency falls below 20 Hz while running. See also Page 2 parameter IR COMP. <b>FLY+BOOST</b> Activates both the Flying Start and Automatic Start Current Boost.

**STOP (FUNCTION) COASTING**

The ACS 200 stops supplying voltage when a Stop command is given and the motor coasts to a stop.

**DEC RAMP**

Ramp deceleration as set in Page 1 parameter DEC 1 (or DEC 2 as selected by digital inputs in Standard and Alternate I/O mode, refer to pages 19 to 21).

**DC BRAKE**

DC injection braking stops the motor by applying d.c. voltage to the stator windings. By using d.c. braking, the motor can be stopped in the shortest possible time, outside of using a dynamic braking resistor.

**DEC+BRAKE**

This should be used only when a brake resistor is connected.

**RAMP** This parameter allows you to select the shape of the acceleration/deceleration ramp as shown in figure 7-2. The available options are:

**LINEAR**

Suitable for drives requiring steady acceleration/deceleration.

**FAST S**

Suitable for ramp times less than one second.

**MEDIUM S**

Suitable for ramp times less than 1.5 seconds.

**SLOW S**

Suitable for ramp times up to 15 seconds.

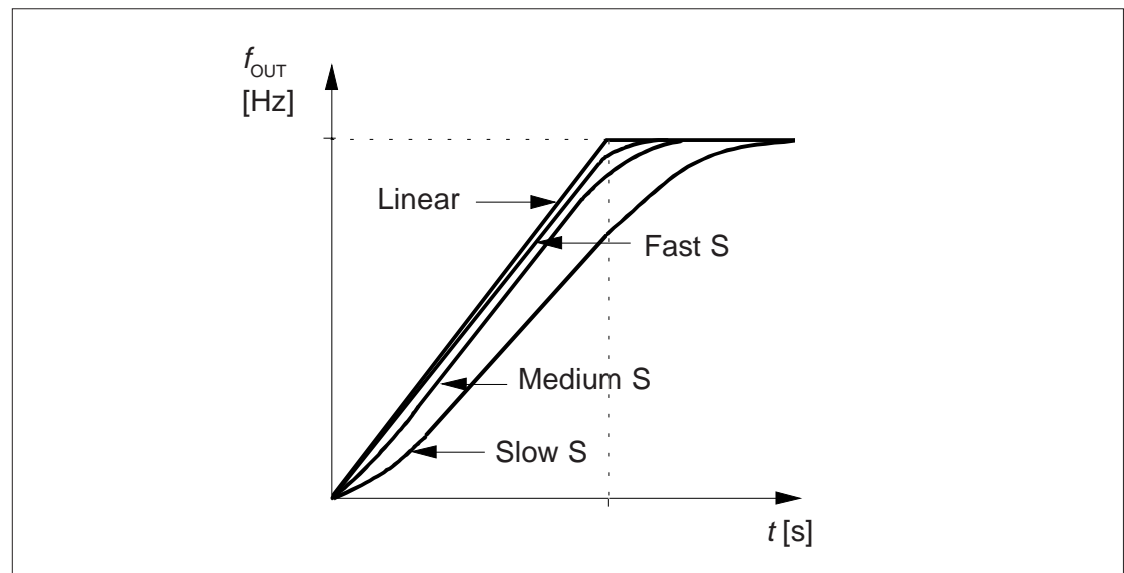

Figure 7-2. Acceleration/deceleration ramp shapes.

REF OFFSET **0 V/ 0 mA**  
**2 V/ 4 mA**

Reference input signal minimum level can be set to either 0 V/0 mA or 2 V/4 mA. The latter value provides a "living zero" function. The drive will stop if the reference drops below the minimum limit. Refer to figure 4-1 on page 17 for selection between current and voltage input.

**JOYSTK 0V0mA**  
**JOYSTK 2V4mA**

Joystick type reference has 0 Hz at 50 % reference. Refer to figure 7-3, below.



**Warning!** If a 0 to 10 V (0 to 20 mA) signal is used in joystick control, the drive will run at MAX FREQ Reverse if the control signal is lost. For joystick control, we recommend that you use JOYSTK 2V4mA offset which will cause the drive to stop if parameter AI-FAULT has been enabled (refer to page 42) and the control signal is lost.

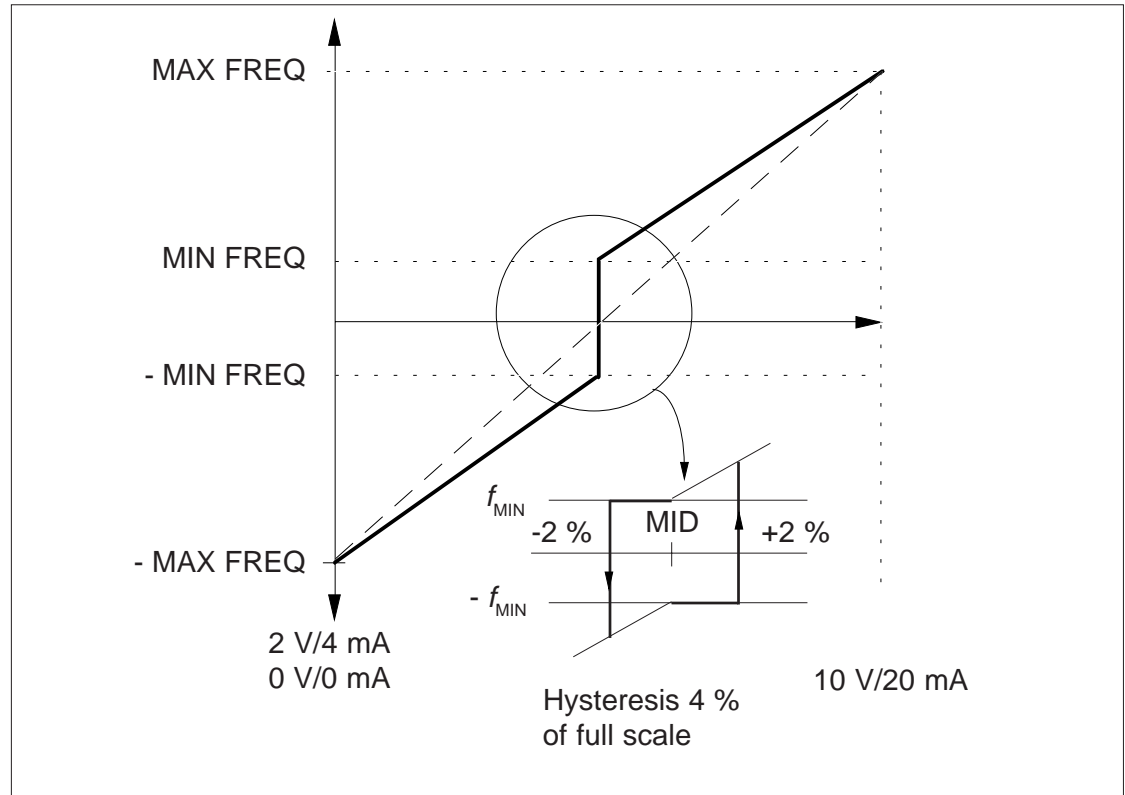

Figure 7-3. Joystick control.

## CUSTOM

Use this setting if you want to set and use customised minimum and maximum limits for the reference input. The customised limits are valid when CUSTOM is selected.

To set the limits, refer to selections SET MIN and SET MAX below.

**SET MIN** (displayed in % of the full input signal range)

**SET MAX** (displayed in % of the full input signal range)

Sets the minimum/maximum limit for the reference input signal. To set the minimum reference signal level, scroll to SET MIN and apply the analogue input signal that represents minimum frequency in your system. Press and hold the **\*** key for three seconds. The setting is accepted when \* flashes once on the Control Panel display. To set the maximum reference signal level, scroll to SET MAX and repeat the procedure as for SET MIN.

**Note!** The drive will stop, a fault message "LOW AI-SIGNAL" appears and the fault LED lights if para. AI-FAULT (refer to page 42) has been enabled and the reference drops below the selected minimum limit.

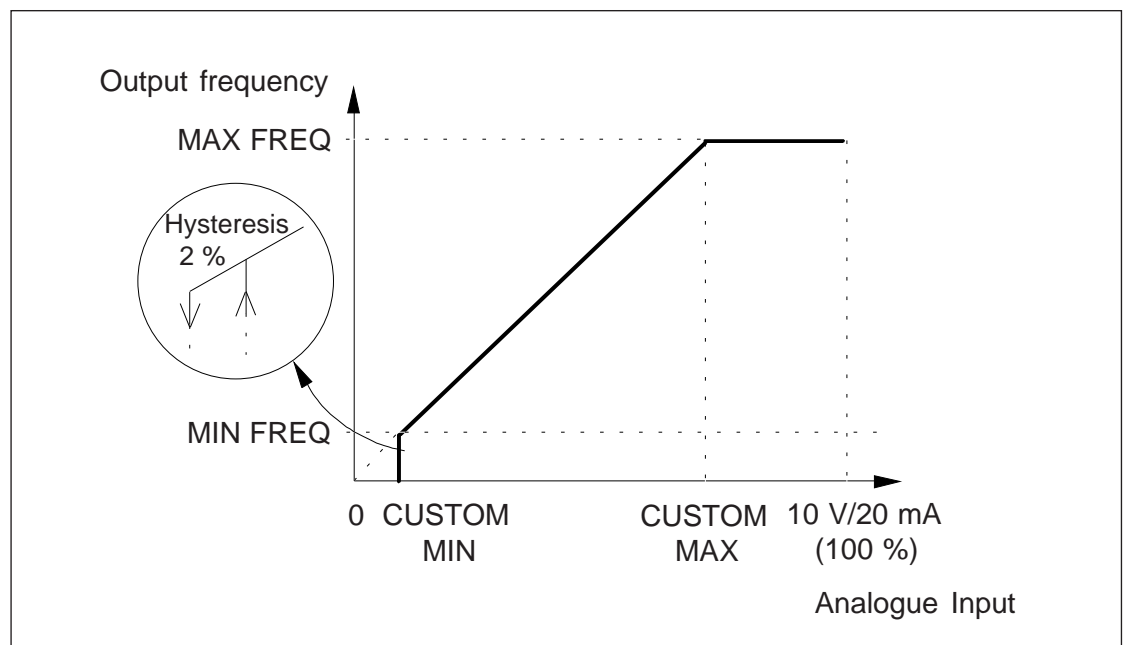

Figure 7-4. Customised minimum and maximum limits for the reference input.

- A. OUT This parameter selects which signal is connected to analogue output.
- NONE** = Analogue output is 0 mA
  - OUT FREQ** = Output frequency (0 to the selected maximum frequency)
  - REF FREQ** = Reference frequency (0 to the selected maximum frequency)
  - MOTOR CUR** = Motor current (0 to  $1.5 * I_N$  / 0 to  $1.2 * I_N$  for ACS 201-4P1-1)

A. OUT OFFS The analogue output signal minimum can be set to 0 mA or 4 mA. The maximum output remains 20 mA. Selecting 4 mA provides a "living zero" function. If a fault occurs, the output current will drop to 0 mA as an alternate fault indicator signal.

SWITCH f Motor noise can be minimised by adjusting the switching frequency to a value that does not create resonances in the motor system. The optimum switching frequency is the lowest frequency where the noise is acceptable. This frequency may not be the same for identical motor systems. As the switching frequency goes up, the inverter efficiency goes down (refer to figure 2-1 on page 9), so it is best to use a low switching frequency if the application can tolerate noise.

**Note!** At output frequencies less than 12 Hz, the switching frequency may be automatically reduced.

CRIT f1L In some systems it may be necessary to avoid certain frequencies because of mechanical resonance problems. With these parameters it is possible to set up two different frequency ranges that the ACS 200 will skip over. It is not necessary that, for example, CRIT f2L be greater than CRIT f1H, just as long as the LOW parameter in one set is lower than the HIGH parameter in the same set. Sets may overlap, but the skip will be from the lower LOW value to the higher HIGH value.

**Example:** Fan system with bad vibration from 18 Hz to 23 Hz and from 46 Hz to 52 Hz. Running speed set to 60 Hz with reference. Set the parameters as follows:

CRIT f1L = 18 Hz; CRIT f1H = 23 Hz; CRIT f2L = 46 Hz; CRIT f2H = 52 Hz

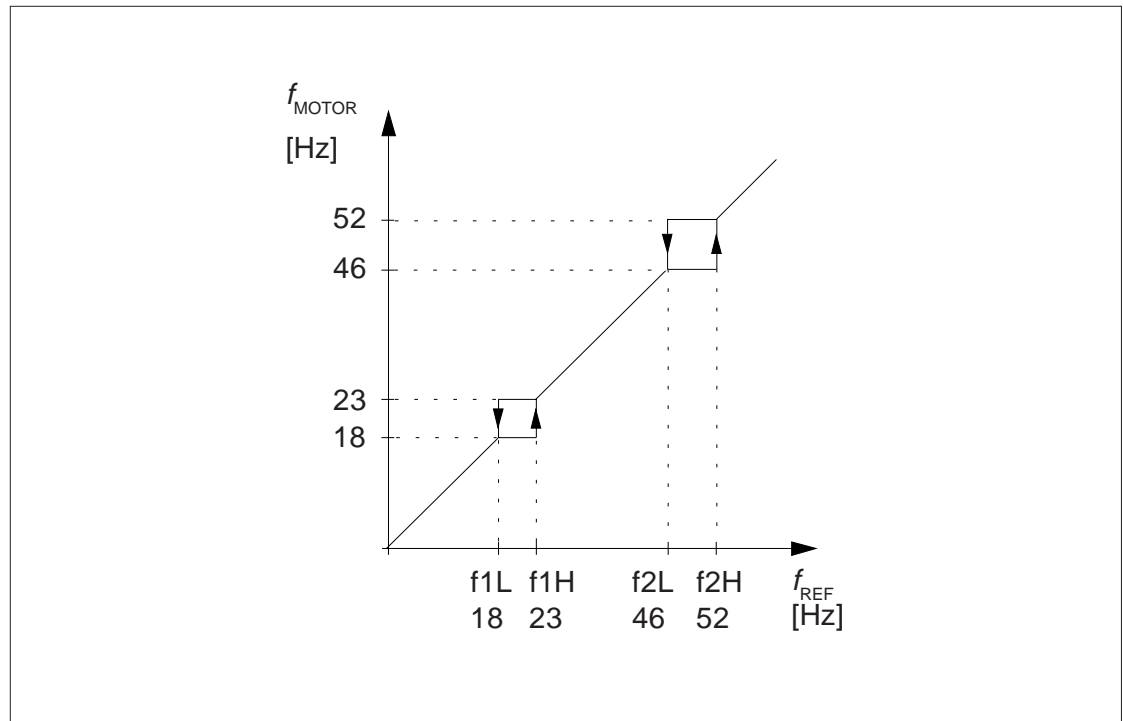



Figure 7-5. Example of critical frequencies setting in a fan system with bad vibrations at frequency ranges 18 Hz to 23 Hz and 46 Hz to 52 Hz.



The following is an alternate way to enter the LOW and HIGH settings for critical frequency:

- Run the drive with external reference.
- Using the analogue input, set the frequency to the critical frequency LOW value.
- Go to parameter CRIT f1L on Page 2.
- Press and hold the  key for three seconds.
- The ACS 200 will respond by updating the frequency setting to the current value. The CRIT f1L is now set.
- Increase the analogue input reference so that the output frequency is just above the critical frequency span.
- Go to parameter CRIT f1H on Page 2.
- Press and hold the  key for three seconds.
- The ACS 200 will respond by updating the frequency setting to the current value. The CRIT f1H is now set.

Repeat the procedure for the second critical frequency range if necessary. The frequency values can be edited when the drive is stopped. To erase the critical frequencies, set both to 0 Hz.

**IR COMP** This parameter allows extra torque at speeds between 0.1 Hz and the nominal motor speed. The parameter differs from the AUTO BOOST option of the START parameter in that it is always valid in the 0.1 Hz to nominal motor speed range.

Keep the boost voltage as low as possible for the application, as the motor will overheat rapidly or an overcurrent fault may occur if a high level of compensation is applied.

Small motors can take higher compensation than larger motors because the winding resistance is higher in small motors. If the motor must drive a load with a high starting torque, we recommend using AUTO BOOST starting. If the load torque is high below the nominal motor frequency, use just enough IR compensation to drive the load. If you have trouble with motor overheating, use a motor with more poles and run at a higher frequency.

If the IR Compensation is set too high, the motor can "saturate" and will not rotate at all, but will draw current.

#### **OFF**

No compensation wanted.

#### **0.1 - 60 V**

The compensation voltage given by the user.

#### **AUTO**

The compensation voltage is automatically given to maintain or reduce current accordingly.

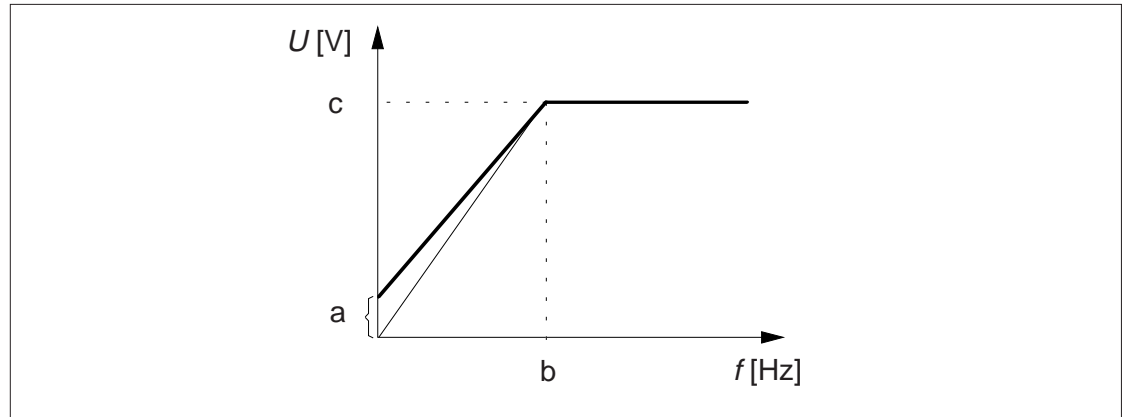

Figure 7-6. IR compensation is implemented by applying extra voltage to the motor.  $a = IR$  compensation voltage,  $b =$  nominal motor frequency (NOM FREQ),  $c = U_N$

- DC-BRAKE** When the STOP parameter is set to DC BRAKE, this parameter sets the d.c. injection time in seconds. If the braking time is too short, the drive stops by coasting after the d.c. braking time has elapsed.
- U/f RATIO** The voltage to frequency ratio in the frequency range 0 Hz to nominal motor frequency can be set to either LINEAR, SQUARE or OPTIM.

#### LINEAR

The voltage of the motor changes linearly with frequency in the constant flux range. Linear U/f (V/Hz) ratio is normally used in constant torque applications, or where the torque characteristics of the load are linear with speed.

#### SQUARE

Squared U/f (V/Hz) ratio is normally used in applications where the torque characteristic of the load is proportional to the square of the speed, such as centrifugal pump or fan systems.

#### OPTIM

The motor voltage is automatically controlled to minimise the motor losses and noise. This setting is suitable for a drive which has a slowly changing load torque and a motor which operates mainly below nominal load.

**Note!** Parameter MOTOR I must be set correctly for best results.

**Note!** OPTIM cannot be used in a system where two or more motors are connected in parallel to one ACS 200.

- RESTART #** Number of times the ACS 200 will automatically reset the fault and restart after any of the following faults: Undervoltage, Overvoltage, Overcurrent, Low AI-Signal, Unit Fault. For further information on fault tracing refer to chapter 8 Fault Tracing page 44. If you select OFF, the automatic fault reset system is not in operation.

**TEMP LIM** The ACS 200 motor thermal protection (sometimes called  $I^2t$  or solid state overload protection) is activated using the TEMP LIM parameter. When set to OFF, the motor overload protection is deactivated. The TEMP LIM and MOTOR I parameters define the continuous safe operating area for the motor, as illustrated in figure 7-7.

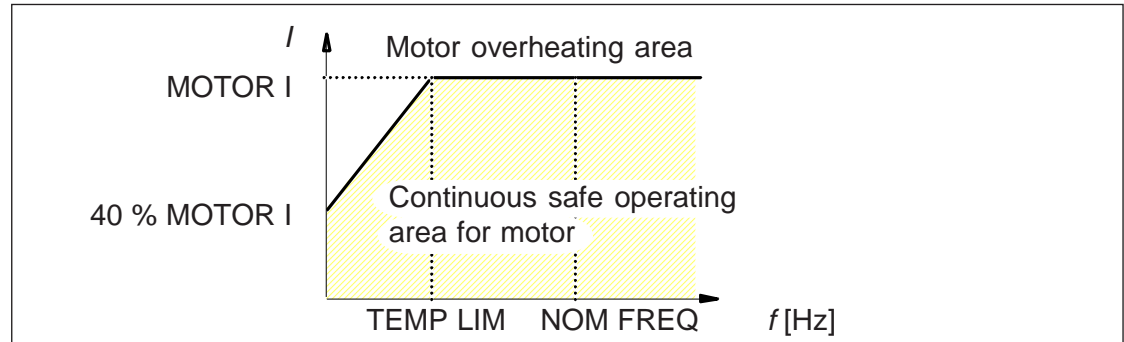

Figure 7-7. Motor thermal protection.

When the motor current exceeds the level determined by the safe operating area, the ACS 200 will begin calculating excessive temperature rise in the motor. When the ACS 200 has determined that the motor has exceeded its allowable temperature rise, it will stop the motor, indicate a "MOTOR TEMP" fault and activate the fault relay. The fault can be reset, when the motor has cooled down to a safe temperature. ACS 200 will continue to calculate the motor temperature even if the motor is not running. If the ACS 200 is disconnected from the mains, the overload protection calculation is reset, and the motor is assumed to be at ambient.

The motor thermal protection function is designed to protect motors even at low speeds by decreasing the allowable operating current. This is necessary as the motor's cooling fan becomes less efficient at low speeds.

Motors have a specified constant torque operating range, which defines the minimum speed a motor can still be driven at rated current (and provide constant torque). This speed is typically stated as a ratio (i.e. 2:1, 4:1, etc.). This ratio can be converted to the proper TEMP LIM entry by the following equation:

$$\text{TEMP LIM (Hz)} = \text{NOM FREQ (Hz)} / \text{ratio}$$

*Example 1: The typical ratio for an IEC motor rated at 50 Hz is 5:4.*

$$\text{TEMP LIM (Hz)} = 50 \text{ Hz} / (5/4) = 40 \text{ Hz}$$

*Example 2: A 2 hp motor is installed with an ACS 201-2P7-3. The motor has a rated current of 3.4 A (460 V, 60 Hz) and a speed range of 4:1.*

$$\text{TEMP LIM (Hz)} = 60 \text{ Hz} / 4 = 15 \text{ Hz}$$

This means the motor can draw full current down to 40 Hz (1) or 15 Hz (2), and still have enough cooling efficiency to operate safely. Please consult the motor manufacturer for the correct speed ratio when applying the motor overload protection feature.

#### MOTOR I

Nominal motor current at full load as indicated on the motor rating plate. See U/f RATIO, TEMP LIM and figure 7-7 above. This parameter does not need to be set if TEMP LIM is set to OFF and OPTIM U/f RATIO is not used. MOTOR I does not

DIR restrict the I LIMIT parameter.

AI-FAULT If DIR parameter is set to FWD ONLY, local and external direction commands are disabled and the motor rotational direction is fixed to forward.

This parameter allows you to disable Analogue Input signal fault detection. If AI-FAULT is set to DISABLE and the reference minimum is set to 2V/4mA, CUSTOM or JOYSTK 2V/4mA, the reference is set according to 2V/4mA input when the control signal is lost. Analogue input fault is not indicated and not stored in Fault History.

P. LOCK Parameter Lock prevents unauthorised persons from altering the parameters. If the Parameter Lock is active, it is not possible to select the Setting mode and "PARAMETER LOCK" displays on the Control Panel display if you try to enter Setting mode.

**OPEN**

The Parameter Lock is open allowing the parameter values to be changed.

**LOCKED**

RELAY FUNC This parameter allows you to select the information indicated with Relay Output.

Code	Function
1	Fault
2	Power
3	I > Current limit
4	> Frequency limit
5	< Frequency limit
6	Motor is running forward
7	Motor is running
8	Motor overtemperature trip
9	Under panel control (LOCAL)
10	None
11	Fault (-1)

**1 (Fault)**

Relay is de-energised (and the Fault LED on the Control Panel illuminates), when a fault occurs.

**2 (Power)**

Relay is energised all the time (after initialisation of the program). **Note!** The relay is energised when this function is selected.

**3 (I > Current Limit)**

Relay is de-energised for a minimum of 250 ms whenever the output current exceeds I LIMIT. The time is for hysteresis and slow response of indication devices. Relay is energised when current is reduced below I LIMIT.

#### 4 (>Frequency limit)

Relay is de-energised when the output frequency exceeds the value selected with parameter F SUPERV. Relay is energised when output frequency is below (F SUPERV - hysteresis). If F SUPERV is greater than 10 Hz the hysteresis is 2 Hz, otherwise hysteresis is 20 % of F SUPERV.

#### 5 (<Frequency limit)

Relay is de-energised when the output frequency falls below the value selected with parameter F SUPERV. Relay is energised when output frequency is more than (F SUPERV + hysteresis). If F SUPERV is greater than 10 Hz the hysteresis is 2 Hz, otherwise hysteresis is 20 % of F SUPERV.

#### 6 (Motor Is Running Forward)

Relay is de-energised, when the motor is running and the direction is forward (according to the status of the modulator, not the reference or switches).

#### 7 (Motor Is Running)

Relay is de-energised, when the motor is running (according to the status of the modulator, not the reference or switches).

#### 8 (Motor overtemperature trip)

Relay is de-energised while the Motor Overtemp fault is active. Other faults can also be active while the relay is de-energised.

#### 9 (Under Panel Control (LOCAL -state))

Relay is de-energised while the LOCAL -state is active (REMOTE LED on the panel is not illuminated).

#### 10 (None)

Relay is never energised. **Note!** Relay is de-energised, if this function is selected while the relay is energised.

#### 11 (Fault (-1))

Relay is energised (and the fault LED on the Control Panel illuminates), when a fault is active.

---

**Note!** When planning the application of the programmable relay, do not forget that the relay is always de-energised when the drive power is shut off.

---

# 8 Fault Tracing

---

The Parameter Lock is active. The parameter values cannot be changed.

This chapter describes the ACS 200 fault indications and fault memory. It also explains how to trace faults.

The ACS 200 continuously monitors itself for faulty operation. If a fault condition should arise, a fault indication is displayed, the fault LED illuminates and ACS 200 waits for the operator to acknowledge the fault before resuming operation.

An active fault can be reset either by pressing the keypad  button, deactivating the Start input (DI1) or switching the input voltage off for a while. If the fault has been removed, the ACS 200 will resume normal operation. If the fault has not been removed, the ACS 200 will trip again. For automatic fault reset, refer to parameter RESTART # on page 39.

**Note!** If the Start command is active and the fault has cleared, fault resetting starts the drive.

Some faults require you to cycle the power off and on once before the fault can be cleared. Proper fault reset action is given in table 8-1.

When a fault is detected, it is stored so that it can be reviewed at a later date. The last three faults are stored in Page 1 parameter FAULT MEMORY. The faults can be checked for trends that may be useful in preventing future faults. For example, if the last two out of three faults were overvoltage trips, the deceleration time should be longer or you should install a braking resistor.

Scrolling through the FAULT MEMORY does not erase the FAULT MEMORY. The oldest resetted fault indication is automatically erased when a new fault occurs.

**Note!** Undervoltage fault is stored in FAULT MEMORY if the fault occurs and automatic restart (RESTART #) is off. If the automatic restart is on, the undervoltage fault

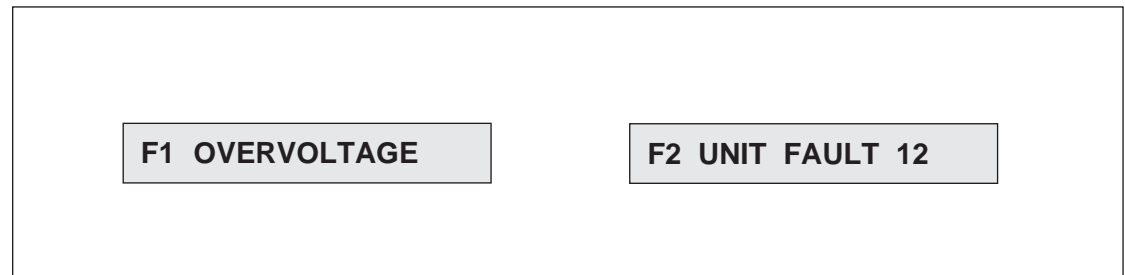

Figure 8-1. Examples of fault indications in the fault memory.

## Fault tracing





### Fault indications



is not stored in the FAULT MEMORY unless the fault persists after restart.

Table 8-1 shows the displayed fault text (in the FAULT MEMORY); the probable cause of the fault; and advice for correcting the fault. If the selected display language is "Code", the fault is identified using the number given in the table in parenthesis before the fault indication.











 = Press once to reset fault.

  = Switch power off to reset fault.

Fault indication	Possible cause	Remedy
(1) NO FAULT	This message only appears in the fault memory.	
(2) OVERVOLTAGE 	DC bus voltage has exceeded 130 % nominal voltage. Overvoltage is generally caused when the motor runs as a generator in drives where the load inertia is extremely high and the deceleration time is set low.	<ul style="list-style-type: none"> <li>• In case of temporary supply voltage peak, reset and start.</li> <li>• Use longer deceleration time or</li> <li>• Use coasting stop function if it is compatible with the application.</li> <li>• If short deceleration time is needed, use Dynamic Braking Resistor.</li> </ul>
(3) UNDER-VOLTAGE 	DC bus voltage has gone below 65 % of the nominal voltage. Most common reason for low voltage trip is failure in the mains supply, loss of phase or "brown out" condition. Internal failure in ACS 200 can also cause a low voltage trip.	<ul style="list-style-type: none"> <li>• In case of temporary supply voltage drop, reset and start.</li> <li>• Check mains input.</li> <li>• If mains input is adequate, an internal failure has occurred. Contact the nearest ACS 200 supplier.</li> </ul>
(4) OVERCURRENT 	ACS 200 has determined that the motor is operating in the overcurrent region. The motor is not turning because of increased load torque. Motor may be too small for the application.	<ul style="list-style-type: none"> <li>• Remove mechanical problem causing increased load torque.</li> <li>• Check dimensioning, use larger ACS 200 and motor if necessary.</li> </ul>
(5) LOW AI-SIGNAL 	Analogue input less than 2 V/4 mA and minimum has been set to 2 V/4 mA or Analogue Input less than selected "customised minimum".	<ul style="list-style-type: none"> <li>• Input reference has failed or control cable is broken. Check the reference circuit.</li> </ul>
(6) PANEL COM ERR 	Control Panel was removed when control was in Local mode. Due to safety reasons, the drive stops in this fault condition.	<ul style="list-style-type: none"> <li>• Attach the Control Panel and reset the fault, then change to Remote mode and remove Panel.</li> <li>• Use remote (wired) controls to reset the fault, then start and run with remote controls.</li> </ul>

Fault indication	Primary check	Secondary check
<p>(7) - (8), (10) UNIT FAULT 7-8 UNIT FAULT 10</p> <p>Reset and start.</p> 	<p>ACS 200 heatsink temperature high &gt; 90 °C to 100 °C.</p> <p>Heatsink temperature normal.</p>	<p>Heatsink dissipation</p> <ul style="list-style-type: none"> <li>• Dust and dirt: Clean the heatsink. Arrange clean ambient and regular inspection and/or cleaning.</li> <li>• Air flow: Remove obstacles. Ensure free cooling air flow.</li> <li>• Fan (ACS 201-2P1-1 to 4P1-1): Check fan rotation. Check if the cooling fan is stopped when power is on. If the fan is defective, call your ACS 200 supplier.</li> </ul>
		<p>Ambient temperature</p> <ul style="list-style-type: none"> <li>• &gt; 50 °C: Rearrange cooling.</li> <li>• 40 °C to 50 °C: Check the load condition. No overload allowed at this temperature.</li> <li>• &lt; 40 °C: Check the overload condition. 150 % of nominal, 1 min. in each 10 min. allowed at this temperature.</li> </ul>
		<ul style="list-style-type: none"> <li>• Switching frequency &gt; 8 kHz: Reduce to 8 kHz.</li> </ul>
		<ul style="list-style-type: none"> <li>• Refer to "Cabling connections" below.</li> </ul>
<p>(7) - (8), (10) UNIT FAULT 7-8 UNIT FAULT 10</p> <p>Reset and start.</p> 	<p>Cabling connections.</p> <p>Earth faults or short circuits.</p> <p>No visible or measurable defects.</p>	<ul style="list-style-type: none"> <li>• Check for loose contacts in motor cabling.</li> </ul>
		<ul style="list-style-type: none"> <li>• Terminals: Check that terminals in frequency converter end are not defective or damaged.</li> </ul>
		<ul style="list-style-type: none"> <li>• Motor: Check motor terminals and measure earth faults or short circuits in the motor.</li> </ul>
		<ul style="list-style-type: none"> <li>• Cables: Disconnect motor cables and measure earth faults or short circuits in cables.</li> </ul>
<ul style="list-style-type: none"> <li>• Call your nearest ACS 200 supplier.</li> </ul>		





Fault indication	Primary check	Secondary check
(9) MOTOR TEMP 	ACS 200 has calculated that the motor is overheated. As the fault indication is based on calculated temperature rise, the motor may be within safe temperature range.	<ul style="list-style-type: none"> <li>• Check the motor temperature. If it is within acceptable range, adjust TEMP LIM and restart.</li> <li>• Improve motor cooling or resize the motor if the motor temperature is too high.</li> </ul>
(11) - (13) UNIT FAULT 11-13       Reset and start.  	Control connections. 	<ul style="list-style-type: none"> <li>• Terminals: Check the terminal connections for control cabling.</li> </ul>
	Control signals. 	<ul style="list-style-type: none"> <li>• Inputs/Outputs: Ensure that all signals used are good and at an acceptable level.</li> </ul>
		<ul style="list-style-type: none"> <li>• Settings: Check that input/output option switch S1 settings on the Control Card correspond to the required mode. Check that analogue input jumper X5 on the Control Card is set to the correct mode.</li> </ul>
(14) - (16) UNIT FAULT 14-16  	No visible or measurable defects. 	<ul style="list-style-type: none"> <li>• Call your nearest ACS 200 supplier.</li> </ul>
(14) - (16) UNIT FAULT 14-16  		<ul style="list-style-type: none"> <li>• Disconnect the ACS 200 from the mains. Wait until the "Power" LED is off. Reconnect the ACS 200 to the mains and start.</li> </ul>

**Note!** If the fault persists after you have tried the suggested remedy, contact the nearest ACS 200 supplier.

# 9 Technical Data

---

## Mains connection

Fault Memory can be erased by pressing simultaneously -button and -button while reviewing Fault Memory. Erasing will clear all three faults.

**Voltage:** 1 phase and 3 phase, 208 to 240 V  $\pm$  10 % tolerance  
3 phase, 380 to 480 V  $\pm$  10 % tolerance

**Frequency:** 48 to 63 Hz

## Motor connection

**Fundamental power factor:** approximately 0.98

**Voltage:** 3 phase, from 0 to  $U_{\text{MAINS}}$ ;  $U_{\text{MAX}}$  at field weakening point

**Frequency:** 0 to 500 Hz

**Switching frequency ( $f_s$ ):** 1.0 to 16.0 kHz

**Continuous load capacity (constant torque at a maximum ambient temperature of 50 °C, 40 °C for ACS 201-4P1-1 in IP 21):** ACS 200 rated current (if switching frequency  $\leq$  8 kHz)

**Continuous load capacity (constant torque at a maximum ambient temperature of 40 °C):** 1.1 \* ACS 200 rated current (if switching frequency  $\leq$  8 kHz)

**Overload capacity at a maximum ambient temperature of 40 °C:**

- Constant torque:  $1.5 * I_N$ , for 1 minute in every 10 minutes, if switching frequency  $\leq$  8 kHz ( $1.2 * I_N$ , for ACS 201-4P1-1)
- Starting duty:  $1.5 * I_N$ , for 1 minute in every 10 minutes, if switching frequency  $\leq$  8 kHz ( $1.2 * I_N$ , for ACS 201-4P1-1)

**Nominal motor frequency:** 50 to 400 Hz

**Nominal motor voltage:** 200 to 240 V, 380 to 480 V

## Environmental limits

**Acceleration time:** 0.1 to 1800 s/120 Hz

**Deceleration time:** 0.1 to 1800 s/120 Hz

**Ambient operating temperature:**

- Output current  $< I_N$ ,  $f_{\text{SWITCH}} \leq$  8 kHz: 0 to 50 °C (40 °C for ACS 201-4P1-1 in IP 21)
- Output current  $< I_N$ ,  $f_{\text{SWITCH}} >$  8 kHz: 0 to 40 °C

**Storage temperature:** -40 °C to 70 °C

**Cooling method:**

- ACS 201-1P1-1 to 1P6-1: natural air circulation
- ACS 201-2P1-1 to 6P6-3: internal fan

**Relative humidity:** max. 95 %, no condensation allowed

## External control connections

**Altitude:**  $\leq 1000$  m ASL (100 % load capacity); 1.0 % derating every 100 m above 1000 m ASL

### Enclosure classes:

- Main frame IP 20 (without top cover)/IP 21 (with top cover)
- Control Panel IP 65 (when mounted with cable entry and optional sealing)/IP 30 (as loose item)

**One analogue input:** frequency reference

**Voltage reference:** 0 (2) to 10 V, 200 k $\Omega$  single ended

**Current reference:** 0 (4) to 20 mA, 250  $\Omega$  single ended

**Response time:**  $\leq 10$  ms

**Resolution:** 10 bit

**Potentiometer reference:** 10 V -0/+2 %, 10 mA (short-circuit protected)

### Auxiliary voltage

+24 V DC, max. 100 mA

### One analogue output

**Current output:** 0 (4) to 20 mA,  $R_L < 500 \Omega$

**Source (selected by parameter):**

- Output frequency, scaled 0 to maximum frequency
- Output (motor) current, scaled 0 to  $1.5 * I_N$  (0 to  $1.2 * I_N$  for ACS 201-4P1-1)
- Output frequency reference, scaled 0 to maximum frequency

**Accuracy:**

- Frequency outputs  $\pm 2$  %
- Motor current output  $\pm 10$  %

**Ripple:** 1 %

**Response time:** 50 ms

### Five digital inputs

Refer to chapter I/O option switch on page 19 for a description of the functions of the digital inputs.

**One relay output:** common fault

**Max switching voltage:** 300 V d.c./ 250 V a.c.

**Max switching current:** 8 A/24 V d.c. - 0.4 A/250 V d.c.

## Protection

**Max switching power:** 2000 VA/250 V a.c.

**Max continuous current:** 2 A rms

**Short-circuit overcurrent trip limit:**  $2.25 * I_N$

**Slow current regulation limit:**  $1.5 * I_N$  ( $1.2 * I_N$  for ACS 201-4P1-1)

**Overvoltage trip limit:**  $1.35 * U_{240}$ ,  $1.3 * U_{480}$

**Undervoltage trip limit:**  $0.65 * U_N$

**Overtemperature limit:** 90 °C, heatsink

**Auxiliary voltage:** short-circuit protected

## Additional features

**Earth fault protection:** protects only the ACS 200 itself in case of earth fault at motor output

**IR compensation:** up to 60 V or automatic starting torque boost

**Critical frequency lock-out**

**Motor thermal protection**

<b>Analogue input (AI)</b>	<b>Internal braking chopper</b>
	<b>Optional braking resistor</b>
	An analogue input to the ACS 200 is for a user-supplied control signal. The signal may be a speed reference or a process feedback. This signal can be:
<b>DC bus</b>	<ul style="list-style-type: none"><li>• from a manual speed potentiometer</li><li>• DC voltage (0 (2) to 10 V d.c.)</li><li>• DC current (0 (4) to 20 mA d.c.)</li></ul>
	Intermediate d.c. link where the input voltage is rectified and filtered. The d.c. bus comprises:
<b>Default</b>	<ul style="list-style-type: none"><li>• DC potential source (internal rectifier bridge)</li><li>• DC bus capacitors that provide filtration of the d.c. source potential and provide some buffering between the d.c. source and the power inverter section.</li></ul>
<b>Digital input (DI)</b>	Value provided for a parameter as a part of the program when the ACS 200 is started initially. The factory setting is the default.
<b>ESD</b>	The digital inputs (DI) receive bistable (two-state On-Off) control signals from the outside world. An example of such would be a two-position Start-Stop selector switch.
	ESD is an acronym for Electrostatic Discharge. ESD warnings indicate situations in which static electricity can damage circuit boards on the ACS 200. Follow the precautions listed in the Safety Instructions section at the beginning of this manual when installing or removing circuit boards.
<b>Field weakening point</b>	
<b>IGBT</b>	Nominal motor frequency. This is the point at which the output voltage no longer increases as the output frequency is increased. Operation above this point results in reduced motor torque capability while the output kVA remains constant.
<b>IR compensation</b>	An IGBT is a fast switching power transistor. ACS 200 frequency converters use these in the inverter section as part of the process of changing d.c. voltage to a.c. voltage.
	IR compensation is voltage added to the normal motor voltage to compensate for resistive losses in small motors. To realise acceptable starting and running torque at low speeds it may be necessary to add some voltage to the normal voltage/frequency ratio of the drive. Refer to figure 7-5 on page 40.
<b>Joystick control</b>	
<b>Living zero</b>	Joystick control allows you to use a potentiometer for external speed and direction drive control through analogue input AI1.
	Setting the minimum value of the analogue input to 4 mA (2 V) provides the operator a "living zero" function. The existence of a control signal can then be supervised by

<b>Memory Parameter</b>	setting the Page 2 parameter REF OFFSET to 2V4mA or JOYSTK 2V4mA, which causes a fault indication if input is less than 4 mA (2 V). This option is also available through the Page 2 parameter A. OUT OFFS.
<b>RFI</b>	Place where data and instructions are stored for use by the program. A memory address that is used to store data for use by the program. The complete table of parameters is presented in chapter 7 Drive Parameters page 30.

RFI is an acronym for Radio Frequency Interference; stray electromagnetic radiation caused by rapidly changing current. The motor driving signals can create RFI problems if they are not shielded. These problems can interfere with radio and television reception or other control equipment used in the vicinity of the ACS 200.

## A

ACC .....	32
ACS 200 frequency converter .....	7
components .....	7
rating plate identification .....	6
operation overview .....	8
AI-FAULT .....	42
Alternate (I/O mode) .....	19,21
Analogue input .....	18
signal selection .....	17
A. OUT .....	37
Analogue output .....	37
A. OUT OFFS .....	38
Audience, intended .....	5
Auxiliary 24 V DC .....	18

## B

Braking resistor terminals, warning .....	15
---	----

## C

Cable definitions .....	13,17
Cable lengths, recommended .....	13,17
Cabling	
control .....	17
power .....	13

Capacitive current .....	13
Commissioning .....	27
checking parameters .....	28
installation inspection .....	28
safety precautions .....	27
Component descriptions .....	7
Component diagram .....	8
CON f1, CON f2, CON f3 .....	34
Control cables .....	17
Control Card .....	17
Control Card connections .....	18
Control connections .....	17
default .....	19
forward or reverse start .....	21
general industrial applications .....	20
Control connections, illustrated .....	18
Control connections, wired control modes (S1) .....	19
Control mode, selection .....	19
Control Panel .....	23
display .....	23
keys, defined .....	25
keys, illustrated .....	25
operation .....	24
operation example .....	26
COPY .....	32
COS PHI .....	33
CRIT f1H, CRIT f1L, CRIT f2H, CRIT f2L .....	38

## D

DC-BRAKE .....	40
----------------	----





Motor thermal protection ..... 41

## N

NOM FREQ ..... 33

NOM RPM ..... 33

NOM VOLT ..... 33

## O

Operation description ..... 8

OUTPUT f ..... 32

OUTPUT I ..... 32

OUTPUT V ..... 34

## P

P. LOCK ..... 42

Page 1 parameters ..... 30

PAGE 1 PRESS \* ..... 42

Page 2 parameters ..... 31

PAGE 2 PRESS \* ..... 33

### Parameters

checking ..... 28

default ..... 30

logic ..... 26

Page 1 ..... 30

Page 2 ..... 31

Potentiometer ..... 18

Power cabling ..... 13

Power connections, illustrated ..... 16

Power derating curves ..... 9

## Q

Quick reference guide ..... 6

## R

RAMP ..... 35

Rating table ..... 7

REF FREQ/LOC FREQ ..... 32

REF OFFSET ..... 36

Related documentation ..... 6

Relay outputs ..... 18

RELAY FUNC ..... 42

RESTART # ..... 40

## S

S1 Input/Output option switch ..... 19

Safety precautions, start-up ..... 27

Space requirements ..... 10

Specifications ..... 48

SPEEDRPM ..... 32

Standard (I/O mode) ..... 19

START (FUNCTION) ..... 34

STOP (FUNCTION) ..... 35

SUPPLY VOLT ..... 33

SWITCH f ..... 38

## T

Technical data ..... 48

Temperature, maximum ambient ..... 9

TEMP LIM ..... 41

TEMP MOD ..... 34

Terminal block X1 ..... 18

Three-Wire (3-Wire, I/O mode) .....  
19,20

Troubleshooting ..... 44

Type designation ..... 6

## U

U/f RATIO ..... 40



---

ABB Industry Oy  
Power Electronics  
P.O. Box 184  
FIN-00381 Helsinki  
FINLAND  
Telephone +358-0-5641  
Telefax +358-0-564 2681  
Telex +57-12440502 str sf