

Contents		Page
Warning and Caution Notes		5
1. DESCRIPTION		7
1.1	Introduction	7
1.2	Control Facilities	8
1.3	Monitoring Facilities	9
1.4	Motor Characteristics	9
1.4.1	Voltage/Frequency Characteristic	9
1.4.2	Low Frequency Voltage Boost (Ku)	10
1.4.3	Current Limit	10
1.5	Options	10
2. TECHNICAL DATA		11
2.1	Equipment Ratings Table	11
2.2	Cable Lengths	11
3. MECHANICAL INSTALLATION		12
4. ELECTRICAL INSTALLATION		14
4.1	Mains Input / Motor Connections	14
4.2	Control Connections	16
5. COMMISSIONING		18
5.1	Preparation for Switch-On	18
5.1.1	Starting and Stopping the Inverter	18
5.1.2	Direction of Rotation	20
5.1.3	Jog Feature	20
5.1.4	Speed Control	20
5.2	First Switch-On	20
5.3	Parameterisation	21
5.3.1	Changing Parameter Settings	21
5.3.2	Parameter Descriptions	22
5.4	Fault Indications	30
5.5	Fault Relay	31
6. USING CLOSED LOOP SPEED CONTROL		32
6.1	Introduction	32
6.2	Installation of Control Loop Speed Control	32
6.2.1	Scaling Factor of 'Actual Speed'	32
6.2.2	Speed Control Operation	33
6.2.3	Speed Control Optimisation	33
6.2.4	Slip Limit (P35)	33
6.2.5	Sample Rate (P36)	33
7. QUICK REFERENCE GUIDE		34
7.1	Connections	34
7.2	Parameter List	35
7.3	Fault Codes	35

Contents (continued)

Page

Figures

1	Block Diagram Simovert P 6SE21	8
2	Voltage/Frequency Characteristic Curves	10
3	Connection Diagram	15
4	Connection Example	17
5	Fault Code Table	30
6	Closed Loop Speed Control	32

Note

These instructions do not purport to cover all details or variations in equipment, nor to provide for every possible contingency to be met in connection with installation, operation or maintenance.

Should further information be desired or should particular problems arise which are not covered sufficiently for the Purchaser's purposes, the matter should be referred to the local Siemens Sales Office.

The contents of this instruction manual shall not become part of or modify any prior or existing agreement, commitment or relationship. The Sales Contract contains the entire obligations of Siemens. The warranty contained in the contract between the parties is the sole warranty of Siemens. Any statements contained herein do not create any new warranties or modify the existing warranty.

Warning and Caution Notes



WARNING

This equipment contains hazardous voltages and controls hazardous rotating mechanical parts. Loss of life, severe personal injury or property damage can result if instructions contained in this manual are not followed.

Only suitable qualified personnel should work on this equipment, and only after becoming familiar with all safety notices, installation, operation and maintenance procedures contained in this manual. The successful and safe operation of this equipment is dependent upon its proper handling, installation, operation and maintenance.



Definitions

• Qualified Person

For the purposes of this manual and product labels, a qualified person is one who is familiar with the installation, construction, operation and maintenance of this equipment and with the hazards involved. In addition, the person must be:

- (1) Trained and authorised to energise, de-energise, clear, ground and tag circuits and equipment in accordance with established safety practices.
- (2) Trained in the proper care and use of protective equipment in accordance with established safety practices.
- (3) Trained in rendering first aid.

• DANGER

For the purposes of this manual and product labels, DANGER indicates that loss of life, severe personal injury or substantial property damage WILL result if proper precautions are not taken.

• WARNING

For the purposes of this manual and product labels, WARNING indicates that loss of life, severe personal injury or substantial property damage CAN result if proper precautions are not taken.

• CAUTION

For the purposes of this manual and product labels, CAUTION indicates that minor personal injury or property damage CAN result if proper precautions are not taken.

• Note

For the purposes of this manual and product labels, Notes merely call attention to information that is especially significant in understanding and operating the drive.

Hot Line

Siemens operates a telephone 'hot line' for users of their 6SE21 range of inverters. This service is available during normal working hours, Monday to Friday. If you require assistance, contact our customer support personnel on the following number:

Tel: (49) 9131 7 23212

Fax: (49) 9131 7 29900

Please have the following information available before dialling:

- *inverter model number*
- *hardware type (stored in P49)*
- *software version (stored in P50)*

1. DESCRIPTION



WARNING

SIMOVERT P transistorised voltage–source inverters operate with high voltages.

Connection, commissioning and fault–finding should only be carried out by qualified personnel who are fully conversant with the relevant documentation, installation regulations, etc.

Only permanently–wired input power connections are allowed. This equipment must be grounded (IEC 536 Class 1, NEC and other applicable standards).

Safety Note:

Do not apply input power to the equipment when the plastic cover has been removed. Dangerous voltages are present within the equipment which could cause serious injury or death if touched. After removing mains power, always allow a minimum of five minutes for the internal capacitors to discharge before removing the cover.

When the 3–phase mains input is protected by a current–operated earth–leakage breaker, the input to the inverter must be isolated from the mains if the earth–leakage breaker is to operate effectively.

The dc–link capacitors remain charged to dangerous voltages for up to five minutes after the incoming power has been switched off.

When the motor is not running, dangerous voltages are still present on the power input terminals AND motor output terminals and also on the dc–link terminals.

Under certain set–up conditions, the inverter may restart automatically after an input power failure.



1.1 Introduction

SIMOVERT P inverters of the 6SE21 series are designed for low–loss speed control of three–phase motors. This is achieved by rectifying input voltage to establish a dc link voltage, and modulating this link voltage with a three–phase transistor bridge to produce a Pulse–Width Modulated (PWM) three–phase output voltage (*see Figure 1*). The inductance of the motor windings converts this PWM voltage to a sinusoidal motor current. By varying the frequency of this sinusoidal current, the rotational speed of the motor is controlled without significantly affecting the losses in the motor. The output frequency can be adjusted between 0 and 400 Hz.

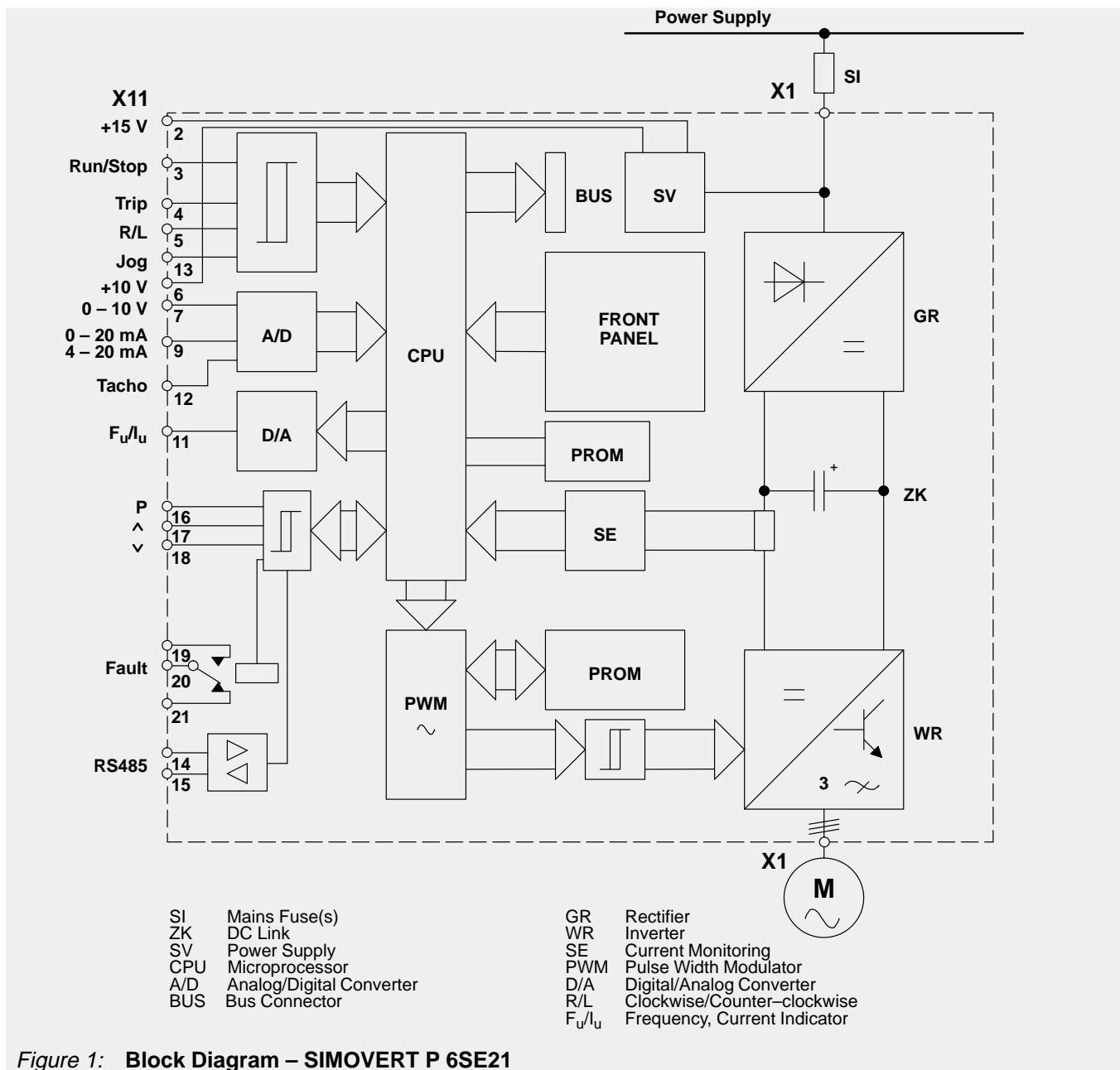

Figure 1: Block Diagram – SIMOVERT P 6SE21

1.2 Control Facilities

The inverter can be started/stopped by any of the following means (see parameter P05 in section 5.3.2 and also Figure 3):

- (1) Connection of a latching switch to the run/stop input (terminals X11.2/3).
- (2) Applying a rising edge (i.e. momentary push-button) to the Run/Stop input (terminals X11.2/3) and a falling edge to the trip input terminal X11.2/4.
- (3) Connection of a voltage level of 7 – 33 V to the Run/Stop input (terminals X11.3/1).
- (4) Automatic starting on application of input power (shorting link terminals X11.2/3).
- (5) Connection of a voltage level of 7 – 33 V to the jog input (terminal X11.13/1).
- (6) Control via the serial I/O connections.

The output frequency of the inverter, and hence the speed of the motor, can be controlled by any of the following means (see 5.3.2, parameter P04 and also Figure 3):

- (1) Connection of 0–10 V control voltage (terminals X11.7/8).
- (2) Connection of a 0–20 mA current loop control input (terminals X11.9/10).
- (3) Connection of a 4–20 mA current loop control input (terminals X11.9/10).
- (4) Connection of a 5 k Ω control potentiometer (terminals X11.6/7/8).
- (5) By digital parameterisation via the push–buttons fitted to the inverter, or via equivalent external push–buttons connected to terminals X11.17 and X11.18.
- (6) Via the serial I/O connection.

1.3 Monitoring Facilities

The following monitoring facilities are available:

- (1) Seven–segment display for output frequency, output current, fault indication or parameterisation. This is viewed through a window in the cover.
- (2) A 0–10 V analogue signal, proportional to output frequency or output current.
- (3) A changeover relay, normally energised when the drive is connected to a suitable input supply. The relay is de–energised when a fault is indicated (see section 5.5).
- (4) The drive may be interrogated via the serial I/O connection.

1.4 Motor Characteristics

The inverter can be adjusted to suit individual motor characteristics in the ways described in 1.4.1 and 1.4.2.

1.4.1 Voltage/Frequency Characteristic

Six voltage/frequency characteristic curves are available plus one programmable curve (see Figure 2). They are intended for the following applications:

- Curve 0: $V_N/50$ Hz (constant torque)
For standard 50 Hz induction motors with linear speed/torque characteristics.
- Curve 1: $V_N/60$ Hz (constant torque)
For standard 60 Hz induction motors with linear speed/torque characteristics.
- Curve 2: $V_N/87$ Hz (constant torque)
For delta–connection of standard induction motors designed for star–connection of 50 Hz input voltage. This increases the speed range over which constant motor torque can be achieved.
- Curve 3: $V_N/120$ Hz (constant torque)
For applications where a constant torque is required over the full operating speed range 0.1 to 120 Hz.
- Curve 4*: $V_N/50$ Hz (torque proportional to speed^{1.5})
For operation of 50 Hz motors driving loads where torque is proportional to (speed)^{1.5}. Typical examples of such loads are fans and pumps.
- Curve 5*: $V_N/60$ Hz (torque proportional to speed^{1.5})
For operation of 60 Hz motors driving loads where torque is proportional to (speed)^{1.5}.
- Curve 6*: Programmable (not shown in Figure 2)
The curve type and corner frequency may be selected by the user.

* Curves 4 and 5 allow variable torque output current values (see section 2.1) to be loaded into parameter P17. Curve 6 may allow variable torque output currents depending on the user–defined curve specified.

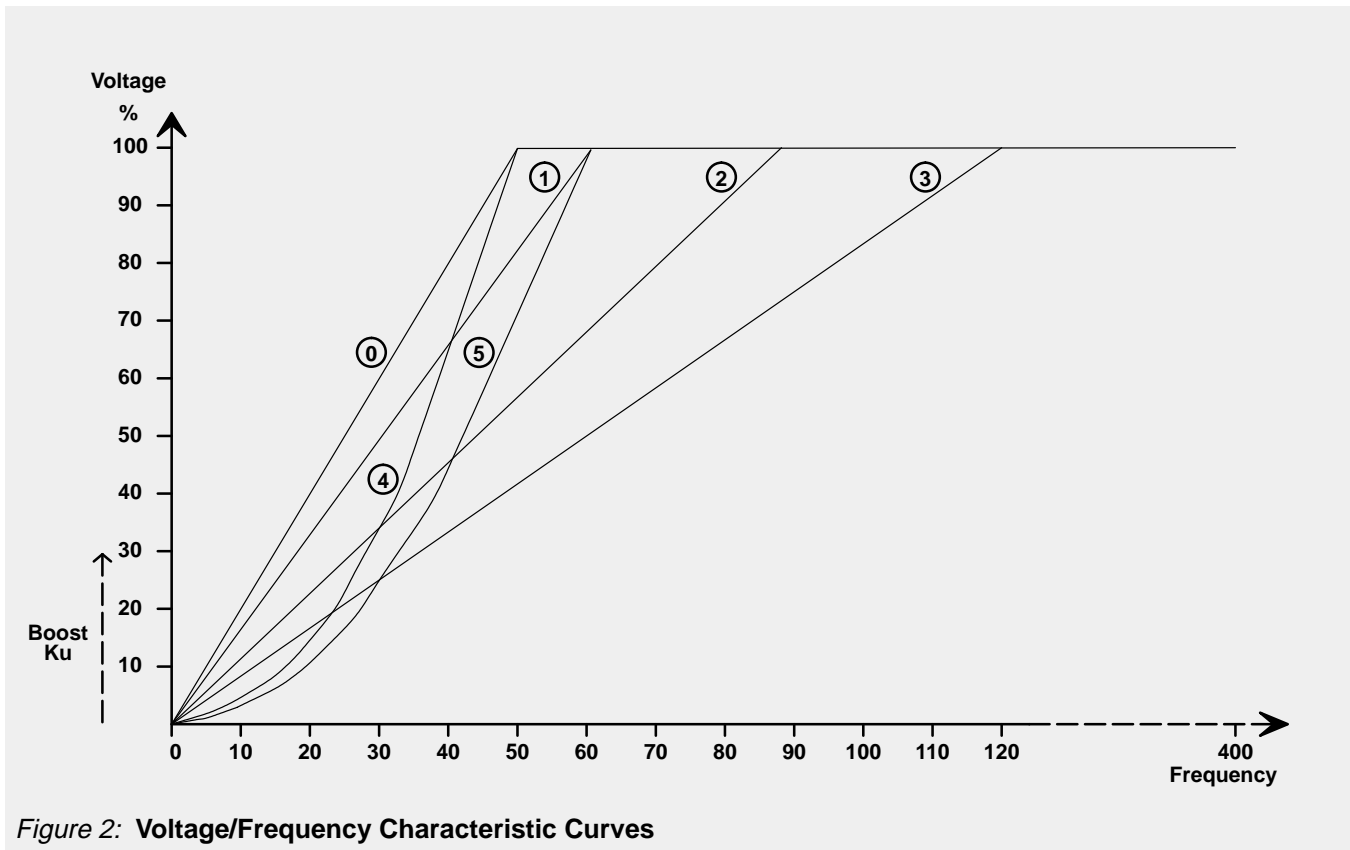

1.4.2 Low Frequency Voltage Boost (Ku)

The output voltage can be boosted in 0.1% steps up to 30% for low frequencies from 0 Hz. This may be required to give additional starting torque in some applications. The amount of voltage boost decreases linearly until 100% voltage is achieved.

If required, automatic boost may be used (see section 5.3.2, Parameter P19). This measures the motor characteristics and selects a suitable boost voltage at first switch-on.

1.4.3 Current Limit

The maximum output current available from the inverter can be adjusted to provide thermal protection of the motor and/or limit the maximum motor torque (see section 5.3.2, parameters P17 and P18).

1.5 Options

The following options are available for use with 6SE21 inverters:

Sinewave Filter Module	Part No. 6SE2100-1FC51/53/55
NAMUR Interface Module	Part No. 6SE2100-1FC50/52/54
Relay Module *	Part No. 6SE2100-1GA00
Tachometer Interface Unit *	Part No. 6SE2100-1DA00
Clear Text Operator Panel *	Part No. 6SE2100-1CA00

* These options cannot be fitted in combination with each other.

2. TECHNICAL DATA

Rated supply voltage: Models 6SE21**–1AA11 Models 6SE21**–3AA21 ** – May be any number	1 AC 50/60 Hz +/-1%, 220 – 240 V +/-10% 3 AC 50/60 Hz +/-1%, 380 – 500 V +/-10%
Output voltage	0 V – rated supply voltage
Output frequency	0.0 – 400 Hz
Efficiency	≥ 0.94
Motor power factor	≤ 0.9 lagging/inductive
Ambient operating temperature (unit must not be exposed to direct sunlight)	0 – 40°C
Storage/transport temperature	–30 – +85°C
Degree of protection	IP21 (NEMA 1)
Humidity	0 – 95% at 25°C
Frequency stability at ΔT_{\max} 10°C referred to f_{\max}	Analogue setpoint 1% Digital setpoint 0.01%
Frequency resolution	0.1 Hz
Overload rating	1.5 x rated current for up to 60 seconds

2.1 Equipment Ratings Table

Model 6SE21..	Input Voltage Range	Max. Cont. Input Current	Circuit Breaker	Constant Torque Output		Variable Torque Output **		Variable Torque Output ** 460 V (USA)		Variable Torque Output ** 500 V		Overload Current
				Continuous Current	Motor Rating *	Continuous Current	Motor Rating *	Continuous Current	Motor Rating *	Continuous Current	Motor Rating *	
01–1AA11	198–264 V 1 phase	9.8 A	16.0 A	2.8 A	.55 kW	3.9 A	.75 kW	–	–	–	–	4.2 A
02–1AA11		13.5 A	16.0 A	3.9 A	.75 kW	4.8 A	1.1 kW	–	–	–	–	5.8 A
03–1AA11		26.5 A	32.0 A	6.8 A	1.5 kW	10.0 A	2.2 kW	–	–	–	–	10.2 A
03–3AA21	342–550 V 3 phase	5.5 A	10.0 A	4.0 A	1.5 kW	5.5 A	2.2 kW	4.8 A	3 hp	4.8 A	2.2 kW	6.0 A
05–3AA21		10.0 A	16.0 A	7.6 A	3.0 kW	9.5 A	4.0 kW	8.1 A	5 hp	8.1 A	4.0 kW	11.4 A
08–3AA21		17.0 A	20.0 A	12.0 A	5.5 kW	17.0 A	7.5 kW	14.0 A	10 hp	12.0 A	7.5 kW	18.0 A
13–3AA21		28.0 A	32.0 A	19.0 A	7.5 kW	23.0 A	11.0 kW	21.0 A	15 hp	19.0 A	11.0 kW	28.5 A
17–3AA21		38.0 A	40.0 A	25.0 A	11.0 kW	32.0 A	15.0 kW	27.0 A	20 hp	25.0 A	15.0 kW	37.5 A
22–3AA21		40.0 A	50.0 A	32.0 A	15.0 kW	38.0 A	18.5 kW	34.0 A	25 hp	32.0 A	18.5 kW	48.0 A
27–3AA21		48.0 A	63.0 A	38.0 A	18.5 kW	46.0 A	22.0 kW	40.0 A	30 hp	38.0 A	22.0 kW	57.0 A
33–3AA21		70.0 A	80.0 A	46.0 A	22.0 kW	60.0 A	30.0 kW	52.0 A	40 hp	46.0 A	30.0 kW	69.0 A
42–3AA21	87.0 A	100.0 A	60.0 A	30.0 kW	75.0 A	37.0 kW	65.0 A	50 hp	60.0 A	37.0 kW	90.0 A	

* Siemens 4-pole motor, 1LA5 series or equivalent.

** Automatically selected on voltage/frequency curve types 4 and 5 (see section 1.4.1).

2.2 Cable Lengths

The inverters will operate satisfactorily with unscreened cables of up to 150 m in length and screened or armoured cable of up to 50 m in length. For applications where longer cables are required, inductors must be fitted to reduce capacitive currents.

Note

If long cables are used, it may be necessary to change the value of parameter P52 to compensate for any inaccuracies in the output current reading.

The following chokes are suitable for applications where up to 100/200 m screened/unscreened cables are required:

Model No.	Choke Type
6SE210*–1AA11 & 6SE2103–3AA21	4EP3601–8DB
6SE2105–/6SE2108–3AA21	4EP3801–4DB
6SE2113–/6SE2117–/6SE2122–3AA21	4EP3800–4DB
6SE2127–/6SE2133–3AA21	4EP4002–1DB
6SE2142–3AA21	4EU2421–8AA00

3. MECHANICAL INSTALLATION



WARNING

High voltages are generated within this equipment. It must only be installed and operated by qualified personnel who are familiar with the equipment, its operating requirements and instructions.



The User is responsible for installation of the motor, drive controller, transformer and other devices in accordance with regulations and local safety codes which may apply.

Adequate protective clothing (e.g. safety gloves, goggles, etc.) should be worn by the person installing this equipment.

Failure to observe the appropriate warnings and regulations may result in serious injury or death.

The inverter must be installed in a vertical position and fixed to a solid surface via its four mounting holes. It is suitable for wall-mounting or installation within a cubicle.



CAUTION

All inverter variants are air-cooled. Ensure that a free space of at least 100 mm (4 in.) is left both above and below the unit to allow an unimpeded air flow.

Avoid subjecting the inverter to excessive shock and vibration.

Installation drawings for the inverters are shown on the next page.

Dimension Drawings

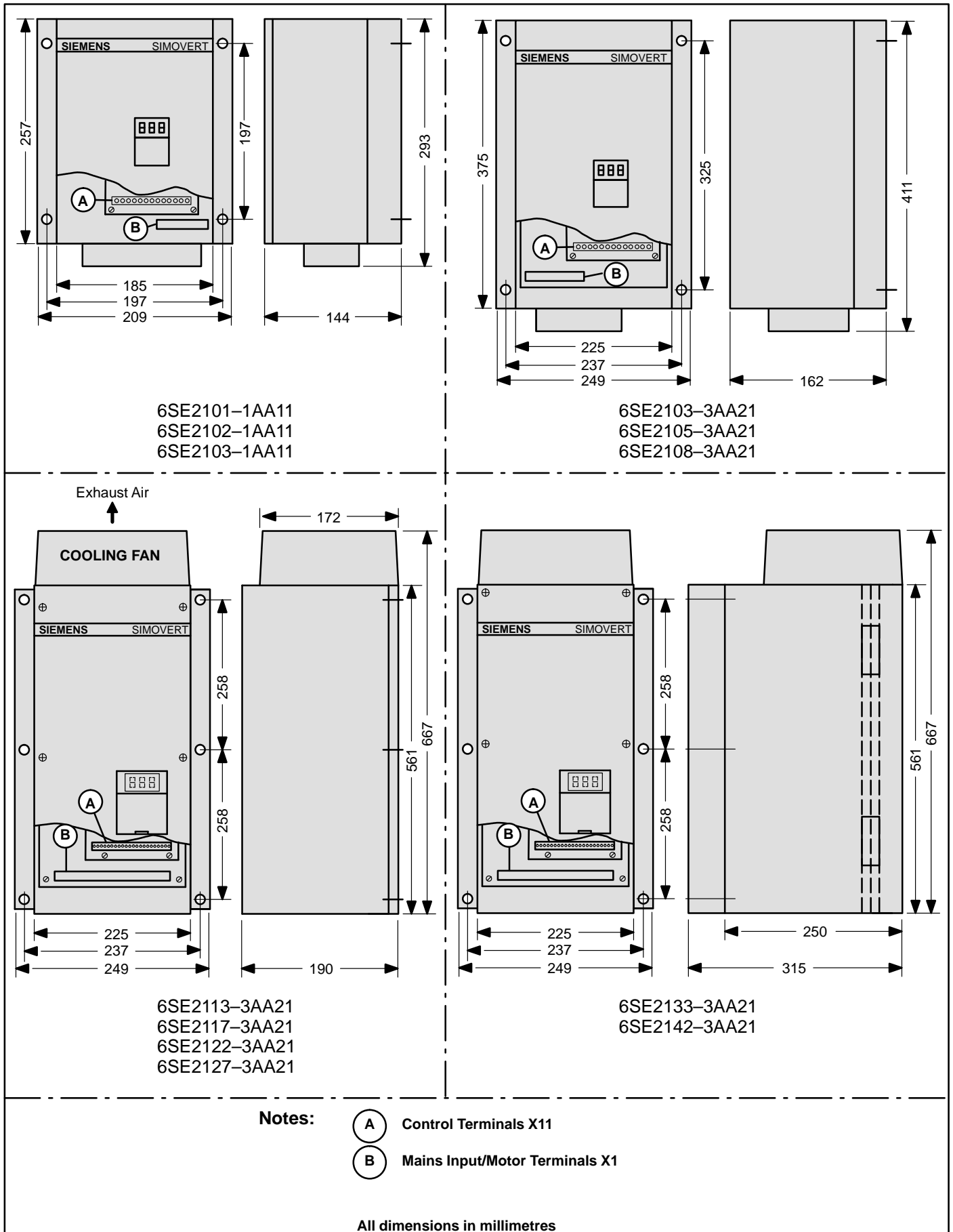

4. ELECTRICAL INSTALLATION



WARNING

Hazardous voltages of over 750 V are used in the operation of this equipment and can cause severe personal injury or loss of life. The following precautions must be observed to reduce risk of injury or death:



- Only qualified service technicians should be allowed to test and repair the equipment or parts thereof.
- Keep all covers in place during normal operation.
- Defective discharge resistors of the dc-link circuit capacitors cause hazardous voltages to remain in the unit for some time. Make sure that the voltage has dropped below 50 V before touching any electrical contacts. Non-observance can lead to severe or fatal injury.
- During commissioning, should it be necessary to make measurements with the power turned on, do not touch any electrical contacts during such work and keep one hand completely free and outside the electrical circuitry.
- Ensure that test equipment is in good and safe operating condition.
- Stand on an ESD-approved insulated surface while performing commissioning work with the power on, being sure not to be grounded.
- When working on the connected motor or motor supply cable, ensure that the input power switch of the equipment for the external feed breaker is padlocked in the OFF position.
- All work on the equipment and its installation must be carried out in accordance with the locally applicable electrical wiring regulations. This includes proper grounding to ensure that no accessible part of the equipment is at line or any other hazardous potential.
- The User is responsible for installation of the motor, drive controller, transformer and other devices in accordance with regulations and local safety codes which may apply. Pay special attention to proper conductor sizing, fusing, grounding, isolating and disconnecting means and to overcurrent protection.
- Failure to ground the inverter properly can result in the surface of the equipment carrying hazardous voltages which may cause severe injury, loss of life or considerable damage to property.

4.1 Mains Input / Motor Connections



WARNING

Only qualified personnel who are familiar with the equipment, its operating instructions and requirements should be allowed to install and operate this equipment.

Incorrect connection of the mains and motor leads (such as connecting the input to the output or connecting excessive supply voltages to the input) will result in damage to the inverter.

First, ensure that an input power supply of the correct voltage and current rating is available – see section 2. Next, ensure that the specified current rating fuse/overload circuit-breaker is connected between the input power source and the inverter.

The power inputs should be connected to X1 on the lower printed circuit board using a three or four-core cable and the motor should be connected using a four-core cable, both suitable for the currents specified in section 2.1. To connect the cable, first remove the plastic cover of the drive by undoing the retaining screws or by levering the retaining clips inwards with a screwdriver. Next, connect the cable to the terminal block X1 as shown in Figure 3.

Connection	Terminal Labelling	Function, Data, Notes
POWER TERMINALS: TERMINAL BLOCK X1		
<i>Single Phase Input Units:</i>		
	U1 N1 PE	X1.L1 X1.N X1.⚡
		Mains Ground
		1AC 220 – 240 V +/-10% 50/60 Hz
	PE	X1.⚡
	U2 V2 W2	X1.U X1.V X1.W
		Ground Motor connection
		3AC 0 V ... Line voltage 0.0 ... 400 Hz
<i>Three Phase Input Units:</i>		
	U1 V1 W1 PE	X1.L1 X1.L2 X1.L3 X1.⚡
		Mains connection Ground
		3AC 380 – 500 V +/-10% 50/60 Hz
	PE	X1.⚡
	U2 V2 W2	X1.U X1.V X1.W
		Ground Motor connection
		3AC 0 V ... Line voltage 0.0 ... 400 Hz
	DC – Output DC + Output	X1.– X1.+
		Connections for Braking Module (EBM)
<i>Use Class 1 60/75°C copper wire only. The tightening torque for field wiring terminals is 1.5 Nm (M4).</i>		
CONTROL TERMINALS: TERMINAL BLOCK X11		
	X11.1	0 V
	X11.2	+15 V
	X11.3	Run/Stop
	X11.4	Trip
	X11.5	Forward/Reverse
		100 kΩ connection to ground Level or edge-triggered (P05) Can be used in conjunction with Run/Stop and with PTC Closed = reverse
	X11.6	+10 V Ref.
	X11.7	0...10 V
	X11.8	0 V
	X11.9	0 (4)...20 mA
		Reference voltage for potentiometer Frequency setpoint (voltage) (P04) Frequency setpoint (current) (P04)
	X11.10	0 V
	X11.11	0...10 V max. load 5 mA
	X11.12	0...50 V
	X11.13	Jog
		Frequency/Output current indication (10 V ≈ f _{max} /I _{max}) Tachometer input Jog speed set by parameter P12
	X11.14	A
	X11.15	B
	X11.16	'P' Button connection
	X11.17	'Λ' Button connection
	X11.18	'V' Button connection
		RS485 Serial I/O connection
	X11.19	NO
	X11.20	COM
	X11.21	NC
	X11.22	0 V
		Fault indication (energised during normal operation)

Figure 3: Connection Diagram

Inverters suitable for use with single phase supplies are fitted with three input terminals (X1.L1, X1.N and X1.≐). Those suitable for use with three phase supplies have four input terminals (X1.L1, X1.L2, X1.L3 and X1.≐).

Connect the motor to terminals X1.U, X1.V and X1.W, ensuring that the motor is correctly connected for the inverter output voltage. For single phase inverters, the motor windings will normally need to be connected in delta form.

Once the cables have been installed, route them through the rubber cable grommets or, if required, use a proprietary cable gland.

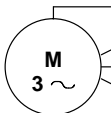
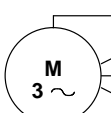
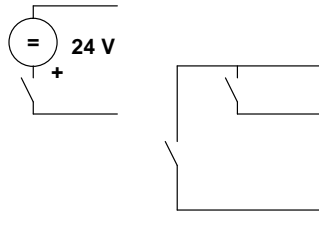
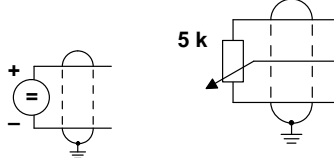
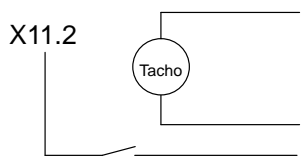
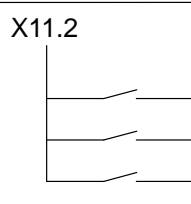
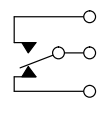
4.2 Control Connections

Make the control connections to the top board (X11) using shielded cable for analogue signals. After installation, route the control cable through the right-hand cable grommet or, if required, use a proprietary cable gland.



IMPORTANT

The control cable should be routed separately from the power supply and motor cables.

The control wires must not run in the same cable duct/trunking as the motor output cables.

Refit the drive's plastic cover.

Figure 4 shows an example of an inverter with typical control connections made. Other control configurations are described in section 5.

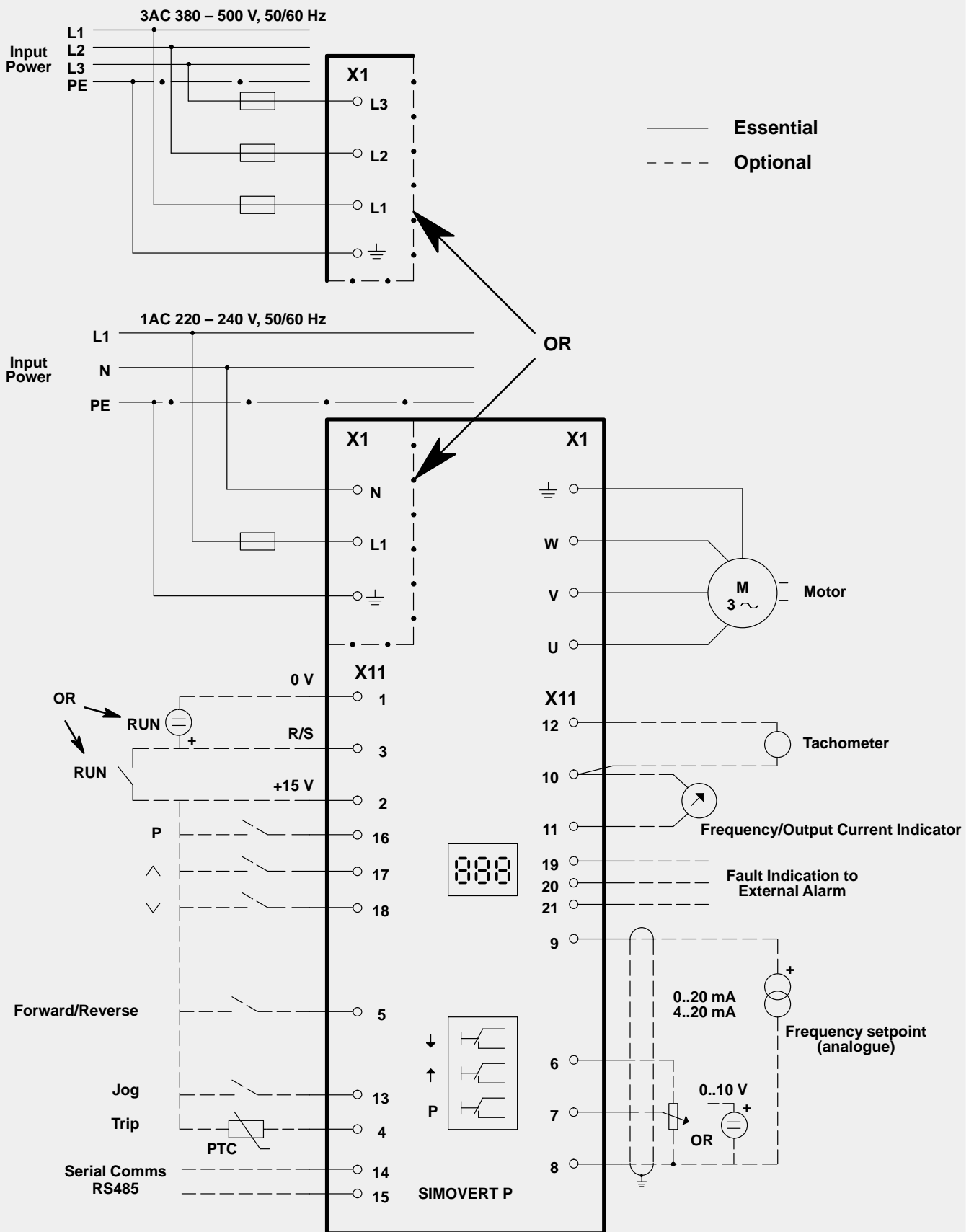

Figure 4: Connection Example

5. COMMISSIONING



WARNING

Hazardous voltages of over 750 V are used in the operation of this equipment.

Read the Warning Notice given at the start of section 4 before proceeding further.

The factory setting of 6SE21-series inverters allows them to be used immediately in many applications. However, matching to specific applications can be accomplished easily by using the wide range of digital parameter settings provided (see section 5.3).

5.1 Preparation for Switch-On



CAUTION

All the features of the 6SE21 inverter may be controlled via the RS485 serial interface. If this is how the inverter is to be used, remember that it may start and stop without warning. Appropriate precautions must be taken to prevent accidents from occurring while the inverter is being controlled in this manner.

If the inverter is to be operated by external remote controls connected via terminal block X11, disable the integral controls to avoid misleading operation and possible damage to the inverter.



WARNING

Ensure that the cover is fitted correctly before switching on the inverter.

Wait at least five minutes after switching off before attempting to remove the plastic cover and work on the equipment. This will allow time for the capacitors within the unit to discharge to a safe level.

Failure to observe these precautions may result in serious injury or death.

5.1.1 Starting and Stopping the Inverter



WARNING

This equipment uses dangerous voltages and controls rotating mechanical machinery.

Dangerous voltages are present on the equipment even after switching off. Isolate elsewhere before attempting to work on the equipment.

Under certain operating conditions the inverter can restart automatically after an input power failure. Ensure that no one is close to machinery controlled by the inverter when such conditions prevail.

DEATH or SERIOUS INJURY can result if the above precautions are not observed.

The method of starting and stopping the inverter depends on the setting of parameter P05. One of three different methods of control may be used in conjunction with one of two different run-down modes. An additional run-down mode which uses dc injection braking may be enabled by adjusting parameter P11.

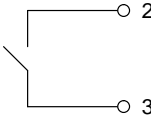
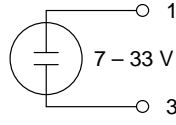
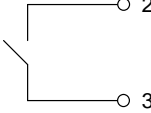
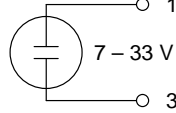
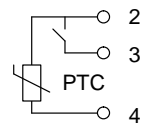
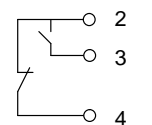
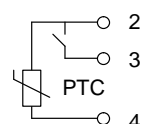
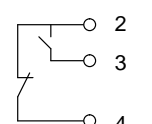
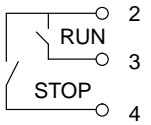
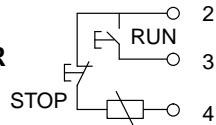
Run/Stop Control	P05 Setting		Typical Configuration	Comments
	Ramps down at a rate set by P03	Free runs to a standstill		
Edge-triggered, Terminal X11.3. Trip Inactive.	000 (Factory Setting)	002	 OR 	Simple control. Does not restart after mains break.
Level-triggered, Terminal X11.3. Trip Inactive.	001	003	 OR 	Simple control. Restarts after mains break.
Edge-triggered, Terminal X11.3. Trip active.	004	005	 OR 	Simple Run/Stop control as above, but high impedance > 2 kΩ X11.2 to X11.4 trips drive & indicates F11.
Level-triggered, Terminal X11.3. Trip active.	006	007	 OR 	Simple Run/Stop control. Restarts after mains break. High impedance > 2 kΩ X11.2 to X11.4 trips drive & indicates F11.
Push-button controls	008	009	 OR 	Inverter starts when RUN button is pressed (momentary action), inverter stops when STOP button pressed (momentary action, normally closed). PTC may also be used, but no fault will be indicated.



CAUTION

Do not restart the inverter or reconnect it to a motor which is already running. Wait for the motor to stop and the inverter to reach zero output frequency before attempting to run the motor/inverter combination again.

If required, a running restart facility is provided by parameter P42 (see section 5.3.2).

The three run-down modes operate as follows:

Ramp-Down (P05 = 000, 004, 006 or 008)

The inverter output frequency will ramp-down at a rate set by parameter P03 until the minimum output frequency (set by P07) is reached. At this point the inverter stops with no output.

Free Run (P05 = 002, 003, 005, 007 or 009)

The inverter output stops immediately, allowing the motor to 'freewheel' to a standstill or to be stopped by other means.

DC Injection Brake

DC injection braking is selected by setting parameter P11 to a value greater than zero. The inverter injects dc into the motor for a period equivalent to the ramp-down time set by P03 plus one second.

5.1.2 Direction of Rotation

The direction of motor rotation can be reversed by applying a voltage level of greater than +7 V to terminal 5 of the control board. This can be achieved by connecting a short-circuit between terminals 2 and 5 on the control board or applying an external control voltage of 7 – 33 V. If no connection is made, the output phase rotation will be clockwise.

5.1.3 Jog Feature

The inverter may be run up to a predetermined frequency (set via parameter P12) by applying an external control voltage of 7 – 33 V to terminal 13 on the control board, or by connecting a push-button between terminals 2 and 13 on the control board. The motor will only run while this voltage is applied, and the input is only active when the drive is stopped.

The jog feature may be used for fine adjustment or 'inching' of equipment.

5.1.4 Speed Control

The motor speed is adjusted by the frequency setpoint. This can be adjusted by analogue means (0–10 V on terminal X11.7 or 0–20 mA / 4–20 mA on terminal X11.9) or digitally by the push-buttons located behind the front panel access clip. These push-buttons may be duplicated by connecting push-buttons to terminals X11.16, X11.17 and X11.18 (see Figure 4). A 10 V reference output is provided on terminal X11.6 so that an external potentiometer can be used. Certain fixed frequency modes may also be selected (see section 5.3.2).

5.2 First Switch-On

Note

Refer to section 6 if the inverter is to be used in conjunction with tachometer feedback. Refer to document no. 6SE2100-0IA64 if the inverter is to be controlled via the serial interface.

- (1) Check input power and connections (see section 4).
- (2) Switch on input power. The display should illuminate and read **00.0**. It will then alternate between **00.0** and the frequency to which the drive will ramp up when started.
- (3) Set the parameters required (see 5.3).
- (4) Set the frequency setpoint. Adjust the analogue setpoint to 0, or set digitally to minimum frequency via P09. (Also see section 5.3.2 for digital frequency setpoint and skip mode operation.)
- (5) Select parameter P00, and then press 'P'. The display should read **00.0**. The display will then alternate between **00.0** and the frequency to which the drive will ramp up when started.
- (6) Switch on the inverter at the run/stop input (see section 5.1.1). The inverter runs to the minimum frequency set by P07, or to the digital frequency setpoint (P09).

Note that if automatic boost operation has been selected (see section 5.3.2), the inverter will measure motor characteristics and startup will be delayed for several seconds. This only occurs at first start up following a change (other than a change to zero) of parameter P19.

- (7) Adjust the low frequency voltage boost (P01) to suit the motor. If required, automatic boost may be used instead (see section 5.3.2). Reset to frequency indication by selecting P00 and pressing 'P'.
- (8) Adjust the motor speed to the required value as shown by the front panel indicator.
- (9) To reverse the direction of rotation of the motor, apply a voltage to the FORWARD/REVERSE input via an external switch. The front panel display and the motor should decelerate through 0 Hz and re-accelerate to the set frequency using ramp values set by P02 and P03.
- (10) To stop the motor, apply a stop signal (see section 5.1.1) or turn off the input power. The motor will run down as defined by parameter P05 (or P11) until the display reads **00.0**.

5.3 Parameterisation

5.3.1 Changing Parameter Settings

Various digital parameters can be adjusted to match the inverter to a particular motor/installation. The procedure for adjustment is described below:

Remove the small cover directly below the LED viewing window by inserting a small blade screwdriver into the slot provided and levering the cover upwards. This will reveal the parameterisation push-buttons:

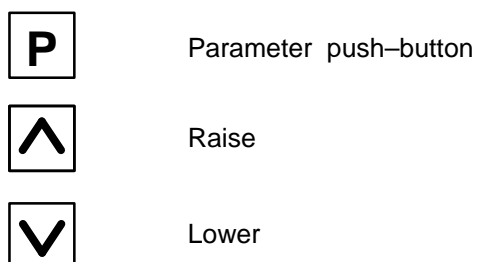

Carry out parameterisation with mains power applied to the inverter. Some parameters can be adjusted while the drive is running (see 5.3.2). If adjustment of a parameter is not permitted, the display will flash when the buttons are pressed.

The parameter number mode is obtained by pressing the parameter (**P**) push-button once. This results in the display showing **P00**. The desired parameter can then be selected using the raise and lower push-buttons.

When the parameter push-button is pressed again, the contents of the selected parameter memory is displayed. The value can then be adjusted using the raise and lower push-buttons. When the desired value has been selected, pushing the parameter button again loads the new value into non-volatile memory and the display once again shows the parameter number.

When all the required parameter settings have been loaded in, return to normal operating mode by selecting **P00** and then pressing **P**. The display will then revert to its normal frequency/output current or fault code indication.

Note

If necessary, all parameters can be reset to the factory default settings. The procedure for this is as follows:

- (1) Press P (P00 displayed).
- (2) Press ^ until P41 is displayed.
- (3) Press P to view the contents of P41 (000 for Europe, 001 for North America).
- (4) Press ^ to change 000 to 001 (Europe), or v to change 001 to 000 (North America).
- (5) Press P to load the new setting into memory.
- (6) Press P again.
- (7) Press v to change 001 back to 000 (Europe), or ^ to change 000 back to 001 (North America).
- (8) Press P.
- (9) Press v until P00 is displayed.
- (10) Press P to return to the normal display.

5.3.2 Parameter Descriptions

Note: Parameters marked with a '•' may be adjusted during operation.

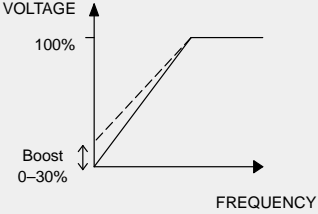
Parameter Number	Description	Display Setting (Default)	Notes
P00 •	Frequency, output current or fault code		
P01 •	Low frequency voltage boost (%)	00.0 – 30.0	<p>The inverter output voltage can be raised to improve the motor torque at low speeds.</p> <p>If the inverter trips and displays F00 when the RUN switch is operated, the low frequency voltage boost should be adjusted upwards in 0.1% increments until the motor starts without tripping. Note that excessive boost can also cause tripping or motor overheating due to the motor current being too high. (Adjustable while the motor is running.)</p> <p>The boost may also be set using the automatic boost feature, set by P19.</p> <p>Note that P01 cannot be adjusted manually when automatic boost is enabled.</p>
	 <p>The graph plots VOLTAGE on the y-axis and FREQUENCY on the x-axis. A solid line shows the voltage increasing linearly from a low frequency to a higher frequency, then leveling off at 100% voltage. A dashed line shows the voltage increasing linearly from a low frequency to a higher frequency, then leveling off at 100% voltage. A vertical double-headed arrow labeled 'Boost 0-30%' indicates the difference between the dashed line and the solid line at low frequencies.</p>	(00.0)	
P02	Ramp up time to maximum frequency (seconds)	00.0 – 400 (10.0)	Short ramp up times will result in high motor currents being drawn during start-up which can cause the inverter to trip (F00).
P03	Ramp down time from maximum frequency (seconds)	00.0 – 400 (10.0)	Short ramp down times will result in voltage regeneration from the stored mechanical energy in the motor which may cause the inverter to trip (F00).
P04	Frequency control mode selection:		
	<u>Analogue Inputs</u>		
	0 – 10 V input (X11.7)	000	0 V = 0 Hz, 10 V = max. frequency P08.
	0 – 20 mA input (X11.9)	001	0 mA = 0 Hz, 20 mA = max. frequency P08.
	4 – 20 mA input (X11.9)	002	4 mA = 0 Hz, 20 mA = max. frequency P08.
	<u>Digital Adjustment</u>		
		003	The frequency of the inverter can be adjusted upwards or downwards using the \wedge \vee keys. However, when the inverter is stopped and restarted, it will always run to the frequency stored in parameter P09.
		004	As 003 but the rate of change of the frequency is fixed (i.e. does not increase after a few seconds). The feature may be useful in some automated control functions.
		005	As 003 but parameter P09 is updated (after a delay of about 3 s) to the new adjusted value. In this case, when the inverter is stopped and restarted, it will run to the new frequency stored in parameter P09.
		006	As 004 but incorporates the P09 update feature of 005.
	<u>Analogue Inputs</u>		
	0 – 10 V input (X11.7)	007	0 V = min. frequency P07, 10 V = max. frequency P08.
	0 – 20 mA input (X11.9)	008	0 mA = min. frequency P07, 20 mA = max. frequency P08.
	4 – 20 mA input (X11.9)	009	4 mA = min. frequency P07, 20 mA = max. frequency P08.
		(000)	
	Note:		Additional fixed frequencies are programmable using parameter P24, which overrides this operating mode.

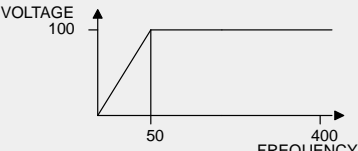
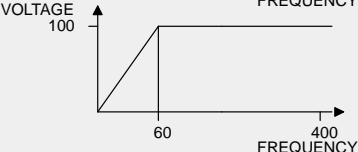
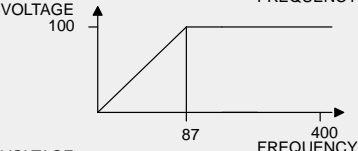
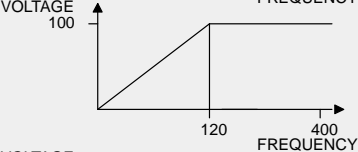
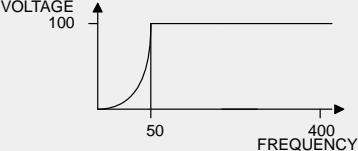
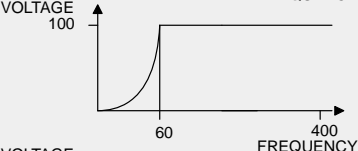
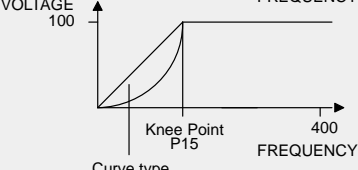
Parameter Number	Description	Display Setting (Default)	Notes
P05	RUN/STOP mode (see section 5.1.1 for detailed explanation)	000	Ramp down; edge-triggered; trip inactive.
		001	Ramp down; level-triggered; trip inactive.
		002	Free run; edge-triggered; trip inactive.
		003	Free run; level-triggered; trip inactive.
		004	Ramp down; edge-triggered; trip active.
		005	Free run; edge-triggered; trip active.
		006	Ramp down; level-triggered; trip active.
		007	Free run; level-triggered; trip active.
		008	Ramp down; push-button control.
		009	Free run; push-button control.
		(000)	
P06	Voltage to frequency curve selection		
		000	Linear 0 – 50 Hz 100% 50 – 400 Hz
		001	Linear 0 – 60 Hz 100% 60 – 400 Hz
		002	Linear 0 – 87 Hz 100% 87 – 400 Hz
		003	Linear 0 – 120 Hz 100% 120 – 400 Hz
		004	Voltage \propto (frequency) ^{1.5} 0 – 50 Hz 100% 50 – 400 Hz (Suitable for use with pumps and fans.)
		005	Voltage \propto (frequency) ^{1.5} 0 – 60 Hz 100% 60 – 400 Hz (Suitable for use with pumps and fans.)
		006	User-defined curve. When this curve is selected, the 'knee-point' and curve type must be selected using parameters P15 and P16.
		(000)	
		[001]	

Parameter Number	Description	Display Setting (Default)	Notes										
P07	Minimum frequency (Hz)	00.0 – 399 (00.1)	<p>Sets the minimum selectable operating frequency. This is temporarily overridden while starting or stopping the motor.</p> <p>The jog frequency may also be set below P07.</p> <p>Notes: (1) With Tacho Mode (P30) = 001 or 003, the inverter will stop under closed loop control until $P37 < P07 + 0.5$ Hz. (2) When the inverter ramps down due to current overload, it will trip with F00 when the output frequency reaches P07.</p>										
P08	Maximum frequency (Hz)	00.1 – 400 (50.0) [60.0]	Sets the required maximum frequency limit. Note that the setting of this parameter will affect the scaling of the analogue control input (P04), ramp rates P02 and P03, and the USS protocol's 100% frequency.										
P09	Digital frequency setpoint adjustment (Hz)	00.0 – 400 (50.0) [60.0]	This parameter sets the frequency to which the inverter will run at startup when parameter P04 has been set to 003, 004, 005 or 006. This value may be updated automatically during operation in certain operating modes selected via P04.										
P10 •	Analogue frequency setpoint adjustment (%)	080 – 240 (100)	This parameter allows the output frequency at a given control voltage/current input to be trimmed. Adjusting this parameter from 100(%) to 080(%) will reduce the frequency corresponding to an analogue input voltage of 10 V (or 20 mA) by a factor of 0.8. Setting the parameter to 240(%) will increase the frequency by a factor of 2.4.										
P11	DC injection braking (%)	00.0 – 20.0 (00.0)	Sets the dc injection voltage as a percentage of the mains voltage. The optimum setting is dependent on motor type and inertia. Too high a level will result in overcurrent and tripping of the drive (F00). Too low a level will result in longer than necessary stopping times. DC injection braking is enabled automatically when P11 is set to a non-zero value.										
P12	Jog (Hz)	00.1 – 400 (05.0)	Sets the inverter frequency reached when the jog control input is active. Overrides the minimum frequency setting.										
P13 •	Slip compensation (Hz)	00.0 – 20.0 (00.0)	<p>Sets the amount of slip compensation (Hz) added to the output frequency when a current equal to the current limit (set via P17) is supplying the motor.</p> <p>Note that excessive slip compensation will cause the motor to increase speed above that equivalent to the original set output frequency and overloading may result.</p> <p>i.e. $f_{\text{output}} = f_{\text{set}} + (P13 \times \text{measured load current}/P17)$</p>										
P14 •	Display status / Analogue output	000 001 002 003 (000)	<table border="1"> <thead> <tr> <th>Display</th> <th>Analogue Output</th> </tr> </thead> <tbody> <tr> <td>000</td> <td>Output frequency</td> </tr> <tr> <td>001</td> <td>Output frequency</td> </tr> <tr> <td>002</td> <td>Output current</td> </tr> <tr> <td>003</td> <td>Output current</td> </tr> </tbody> </table> <p>X11.11 indicates frequency X11.11 indicates current X11.11 indicates frequency X11.11 indicates current</p> <p>(Except during parameterisation or fault conditions.)</p>	Display	Analogue Output	000	Output frequency	001	Output frequency	002	Output current	003	Output current
Display	Analogue Output												
000	Output frequency												
001	Output frequency												
002	Output current												
003	Output current												

Parameter Number	Description	Display Setting (Default)	Notes																	
P20 •	Serial interface selection	000	Local operation – monitoring only via serial interface.																	
		001	Remote operation. Local controls disabled except for P20, which can be selected and adjusted. If P20 is changed while the inverter is operating then it will stop. Note: The trip input remains active if P05 = 004, 005, 006 or 007.																	
		002	USS Protocol (monitoring only)																	
		003 (000)	USS Protocol (monitoring and control)																	
P21	Serial interface address	000 – 030 (000)	Sets the address of the inverter when the serial interface is used.																	
P22	Serial interface parity & baud rate	Sets the parity and baud rate of the serial address:																		
			<u>USS Only</u> <u>(Even Parity)</u>																	
			<u>Parity</u> <u>Baud Rate</u> <u>(Even Parity)</u>																	
		000	Even	2400	9600															
		001	Even	4800	9600															
		002	Even	9600	9600															
		003	Odd	2400	9600															
		004	Odd	4800	2400															
		005	Odd	9600	4800															
		006	Ignored	2400	9600															
		007	Ignored	4800	9600															
		008	Ignored	9600	9600															
			Note: The master unit must still transmit a parity bit in each byte.																	
		(000)																		
P23	Digital input response speed	000	15 ms debounce of digital inputs (for relays or switches).																	
		001	No debounce – suitable for transistor-controlled inputs in control systems which require a fast response.																	
		(000)																		
P24	Fixed frequency mode selection	000	Normal operation – fixed frequency disabled.																	
		001	Selects fixed frequencies. In this mode the inverter only outputs fixed frequencies, ramping between the fixed frequencies at rates set by P02 and P03. The fixed frequencies are selected using \wedge and \vee (terminals X11.17 and X11.18) in accordance with the following table:																	
			<table border="1"> <thead> <tr> <th></th> <th>Freq 1</th> <th>Freq 2</th> <th>Freq 3</th> <th>Freq 4</th> </tr> </thead> <tbody> <tr> <td>(1 = 7 – 33 V) (0 = < 7 V)</td> <td>\wedge</td> <td>0</td> <td>1</td> <td>0</td> <td>1</td> </tr> <tr> <td></td> <td>\vee</td> <td>0</td> <td>0</td> <td>1</td> <td>1</td> </tr> </tbody> </table>		Freq 1	Freq 2	Freq 3	Freq 4	(1 = 7 – 33 V) (0 = < 7 V)	\wedge	0	1	0	1		\vee	0	0	1	1
	Freq 1	Freq 2	Freq 3	Freq 4																
(1 = 7 – 33 V) (0 = < 7 V)	\wedge	0	1	0	1															
	\vee	0	0	1	1															
002	Allows three fixed frequencies (P26, P27 & P28) and one analogue setpoint in accordance with the following table:		<table border="1"> <thead> <tr> <th></th> <th>Analogue Freq</th> <th>Freq 2</th> <th>Freq 3</th> <th>Freq 4</th> </tr> </thead> <tbody> <tr> <td></td> <td>\wedge</td> <td>0</td> <td>0</td> <td>1</td> <td>1</td> </tr> <tr> <td></td> <td>\vee</td> <td>0</td> <td>1</td> <td>0</td> <td>1</td> </tr> </tbody> </table>		Analogue Freq	Freq 2	Freq 3	Freq 4		\wedge	0	0	1	1		\vee	0	1	0	1
	Analogue Freq	Freq 2	Freq 3	Freq 4																
	\wedge	0	0	1	1															
	\vee	0	1	0	1															
			Note: 002 is only valid if P04 is set to 000, 001, 002, 007, 008 or 009.																	
		(000)																		

Parameter Number	Description	Display Setting (Default)	Notes
P25	First fixed frequency (Hz)	00.0 – 400 (00.0)	Fixed frequency.
P26	Second fixed frequency (Hz)	00.0 – 400 (00.0)	Fixed frequency.
P27	Third fixed frequency (Hz)	00.0 – 400 (00.0)	Fixed frequency.
P28	Fourth fixed frequency (Hz)	00.0 – 400 (00.0)	Fixed frequency.
P29	Skip frequency (Hz)	00.0 – 400 (00.0)	This parameter allows a skip frequency to be selected. Operation of the inverter will be inhibited over the range (skip frequency – 2 Hz) to (skip frequency + 2 Hz). If a frequency in this range is selected, the lower or higher frequency will be selected and displayed. Note that during ramping the frequency output will ramp continuously and not 'step' through the skip range.
P30	Tachometer mode		This parameter enables the tachometer input and selects the tachometer calculation rate. See section 6 for further details of tachometer applications.
		000	Tachometer input disabled.
		001	Normal feedback.
		002	Feedback control suspended during ramping.
		003	As 001, except output disabled when frequency falls to P07 (minimum frequency).
		004	As 002, except output disabled when frequency falls to P07 (minimum frequency).
		(000)	
P31 •	Tachometer scale factor	00.0 – 999 (50.0)	Frequency at 50 V tacho input. See section 6 for further details.
P32 •	Feedback compensation: proportional term (%)	000 – 999 (050)	See section 6 for further details.
P33 •	Feedback compensation: integral term (%)	000 – 250 (000)	See section 6 for further details.
P34 •	Feedback compensation: differential term (%)	000 – 250 (000)	See section 6 for further details.
P35 •	Tachometer slip limit (Hz)	00.0 – 20.0 (05.0)	See section 6 for further details.
P36 •	Tachometer sample rate	001 – 200 (001)	n x 30 ms. See section 6 for further details.

Parameter Number	Description	Display Setting (Default)	Notes
P37	Display tachometer frequency reading	000 – 400	Read only.
P40	Switching frequency select	000	19.2 kHz for single phase units. 9.6 kHz for three phase units max. load current for 6SE2108–3AA21 is reduced to 10 A max. load current for 6SE2133–3AA21 is reduced to 25 A max. load current for 6SE2142–3AA21 is reduced to 31 A
		001	19.2 kHz for single phase units. 19.2 kHz for three phase units except 6SE2133–3AA21 and 6SE2142–3AA21 max. load current for 6SE2108–3AA21 is reduced to 8 A for 6SE2133–3AA21 and 6SE2142–3AA21 9.6 kHz max. load current for 6SE2133–3AA21 is reduced to 25 A max. load current for 6SE2142–3AA21 is reduced to 31 A
		002	19.2 kHz for single phase units. 4.8 kHz for three phase units. Note: Use switching frequencies above the factory settings only when acoustic noise generation is critical. If long motor cables (> 30 m) are being used, set the switching frequency to the minimum value.
		(002)	
P41	Parameter default values	000	Selects European default values – shown in parentheses ().
		001	Selects North American default values – shown in square brackets [] where different. Note: Reading the value of P41 does not change parameter settings. To reinstall factory settings, the value of P41 must be changed (e.g. 000 to 001, P, P, 001 to 000).
		(000)	
P42	Auto reset mode	000	Auto reset disabled.
		001	Enables auto reset of fault indications. The unit will attempt to reset fault conditions up to five times within one minute. If the fault condition persists after one minute the display will show the last fault code.
		002	Running restart. When enabled, the inverter starts up at the setpoint frequency and increases its output voltage gradually until it reaches its full operating value. To restart automatically in this way following a line voltage interruption, operate the RUN/STOP signal in level-triggered mode (i.e. P05 set to 001, 003, 006 or 007) and set terminal X11.3 to a voltage > 7 V at power-up. This can be achieved by linking between X11.2 (+15 V) and X11.3. Note: If P005 is set to '006' or '007' (PTC active), connect 7 V or greater to X11.4.
(000)			
P43	Ramp smoothing (%)	000	Linear ramp up / ramp down.
		001 – 100	Ramp rates reduced as frequency approaches the setpoint. The parameter value corresponds to the percentage of the ramp curve that is rounded. i.e.:
		(000)	Note: Total ramp up / ramp down times are extended as this parameter is increased.

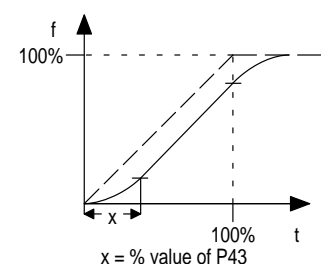

Parameter Number	Description	Display Setting (Default)	Notes
P44	Tachometer interface unit	000	Tachometer interface unit not supported.
		001	Tachometer interface unit Mode 1.
		002	Tachometer interface unit Mode 2.
		003	Tachometer interface unit Mode 3.
		004	Tachometer interface unit Mode 4.
		(000)	
P45	Clear text operator panel language	000	English.
		001	German.
P48	Fault code	000 – 011	Stores the last recorded fault code.
P49	Hardware type		Factory set – cannot be changed.
P50	Software version		Factory set – cannot be changed.
P51	Customer-specific variants	000 – 255 (000)	Do <u>not</u> adjust.
P52	Current monitor scaling factor (%)	001 – 200	Allows compensation to be made for inaccuracies associated with the use of long output cables.
		(100)	

5.4 Fault Indications

In the event of a fault condition arising, the inverter will stop and the display will indicate **F**, followed by a two-digit code (see Figure 5 below).

Fault Code	Cause	Corrective Action
	Excessive load current or Excessive link voltage or Low line voltage (models 6SE21**–3AA21 only).	<p>Ensure rating plate on motor corresponds with inverter rating (see section 2.1).</p> <p>A low frequency voltage boost may be required to start the motor (refer to section 5.3.2, P01).</p> <p>The characteristic voltage/frequency curve of the inverter may not match that required by the motor (refer to section 5.3.2, P06).</p> <p>The acceleration time for the motor may be too short (refer to section 5.3.2, P02).</p> <p>Check whether the motor has stalled or is overloaded.</p> <p>Check for short-circuits or ground faults on the output leads.</p> <p>Ensure line voltage is within the limits specified on the inverter rating plate.</p> <p>The deceleration time of the motor may be too short (refer to section 5.3.2, P03).</p> <p>Check that the voltage of all three input power phases is within the limits specified on the inverter rating plate.</p>
	Excessive heatsink temperature.	<p>Check that the unit has been installed with at least 100 mm clear space above it for exhaust air and that the air inlet at the bottom of the unit is not obstructed.</p> <p>Check that the ambient temperature is below 40°C.</p> <p>Check that the steady motor current is not above the limit specified on the rating plate.</p>
	Corruption of parameterisation data in the non-volatile memory.	Reset all parameters (see section 5.3). Recalibrate the current monitor by removing power from the inverter, pressing all three parameterisation buttons simultaneously while applying power to the inverter. The display will indicate 'CAL' for several seconds while it recalibrates the monitor circuit.
	Faulty operation of the analogue-to-digital converter. Excessive tachometer feedback voltage.	<p>Check that the analogue input voltage on terminal X11.7 is less than +12 V and greater than –0.5 V.</p> <p>If operating in current loop control, check that the current entering control terminal X11.9 is less than 25 mA and greater than –1 mA.</p> <p>Ensure tachometer output does not exceed 50 V at terminal X11.12.</p>
	The minimum frequency parameter (P07) has been set to a higher value than the maximum frequency parameter (P08).	Reset parameter P07 or P08.
	The fixed frequency parameter (P09) has been set outside the minimum/maximum frequency limits set by parameters P07 & P08. Note that this fault indicator will only be enabled if P04 is set to 003.	Reset parameter P07, P08 or P09.

Figure 5: Fault Code Table (Sheet 1 of 2)

Fault Code	Cause	Corrective Action
	Control board fault.	Disconnect the inverter from the input power supply and then reconnect.
	Parameter P25 set above maximum frequency P08 or below minimum frequency P07.	Change parameter P25, P08 or P07.
	Parameter P26 set above maximum frequency P08 or below minimum frequency P07.	Change parameter P26, P08 or P07.
	Parameter P27 set above maximum frequency P08 or below minimum frequency P07.	Change parameter P27, P08 or P07.
	Parameter P28 set above maximum frequency P08 or below minimum frequency P07.	Change parameter P28, P08 or P07.
	Inverter externally tripped via X11.4 input.	Clear external trip on X11.4 and restart the inverter.

Figure 5: Fault Code Table (Sheet 2 of 2)

If a fault indication has been observed and the corrective action implemented, the inverter can be reset by applying a STOP (low) signal to the run/stop input (terminal X11.3) followed by a RUN (high) signal to the same input. Alternatively, the incoming mains voltage can be switched off and then switched on again.

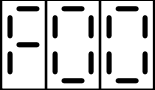
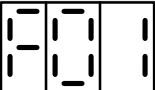
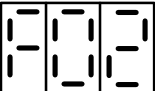
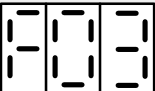
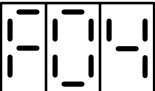
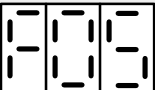
5.5 Fault Relay

A single pole changeover relay is provided to indicate a fault. It is normally energised when the inverter is powered and operating or stopped. If a fault condition occurs, the relay will be de-energised. The contacts of the relay are connected to terminals X11.19 (normally open, de-energised), X11.20 (common) and X11.21 (normally closed, de-energised) on the control board.

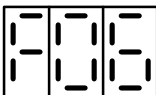
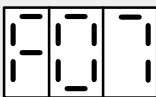
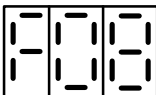
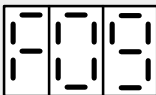
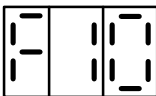
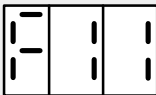
6. USING CLOSED LOOP SPEED CONTROL

6.1 Introduction

Closed loop speed control (see Figure 6) allows the speed of a motor to be regulated to hold constant the analogue value of a speed measuring device (e.g. a tachometer) for a given 'requested frequency' setting of the inverter.

The actual speed signal must be positive and in the range 0 – 50 V.

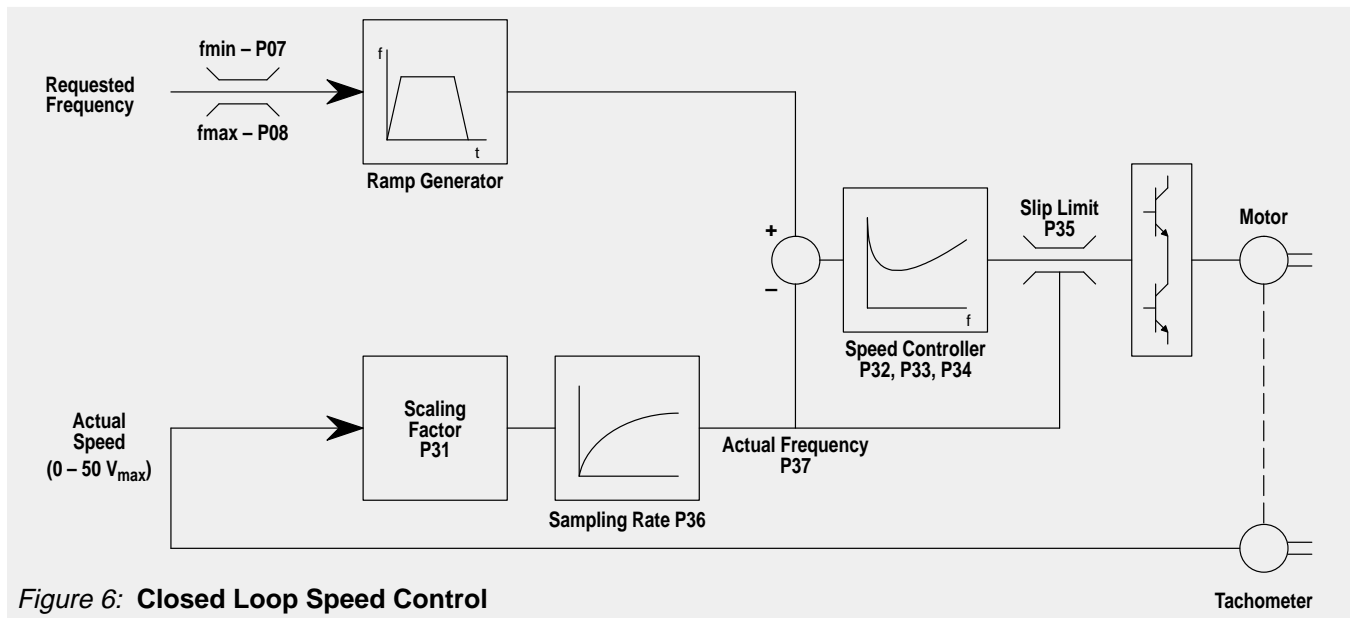

Figure 6: Closed Loop Speed Control

6.2 Installation of Control Loop Speed Control

6.2.1 Scaling Factor of 'Actual Speed'

The actual speed signal is connected to terminal X11.12 (positive) and X11.10 (negative / 0 V). The appropriate voltage from the actual speed measuring device is to be calculated at f_{max} . If the voltage can exceed 50 V at maximum frequency, an external scaling resistor is required. This can be calculated using the following formula:

$$R_{ext} = 50 \text{ k}\Omega \times \left(\frac{V_{max}}{50} - 1 \right)$$

The scaling of the analogue value of the feedback signal can be adjusted with P31. This can be achieved as follows:

- (1) Operate the inverter with the following parameter settings:

P30 = 001	Speed control enabled
P31 = 00.1	Scaling factor
P32 = 001	Speed regulator proportional gain term
P33 = 000	Speed regulator integral gain term
P34 = 000	Speed regulator differential gain term
P35 = 00.0	Slip limit

Ensure that the maximum frequency parameter P08 is set to the correct value for the application. Initially set P09 to the same value as P08 and set P04 to 003.

- (2) Run the inverter. The motor speed will increase until the value stored in P08/P09 is reached.
- (3) With the inverter running at maximum frequency, look at the value of parameter P37 (actual frequency). Adjust the value of parameter P31 (scaling factor) until the value of P37 corresponds to the maximum frequency P08.

Once steps (1) to (3) have been performed, P04 can be changed to match the requirements of the application.

Note

Speed control only operates in one direction of rotation – negative values of the actual speed feedback signal on terminal X11.12 are not permitted.

6.2.2 Speed Control Operation

Stop the inverter and adjust the slip limit (P35) to 10.0 (unless the application requires the slip to be limited to a lower value). Set the required frequency to a value in the middle of the operating range (i.e. approximately half way between the minimum and maximum frequencies required in operation). Set the inverter to run and increase the setting of P32 gradually until the motor speed starts to oscillate. Reduce the value of P32 until a stable speed is obtained.

6.2.3 Speed Control Optimisation

If it is not possible to achieve stable operation with P32 set to a value of greater than 10, there must be excessive noise on the feedback signal. It may be possible to filter out this noise by increasing the setting of the sampling rate parameter (P36). If this fails then the feedback signal should be shielded and, in extreme cases, smoothed using suitable capacitors.

Check the performance of the speed regulation. If the speed regulation is satisfactory when the load on the motor changes then no further adjustments are required. However, the integral term and differential term parameters (P33 and P34 respectively) allow further adjustments to be made to the control loop to compensate for delay and/or lead terms in the motor and its associated speed sensor. This can provide better speed regulation in certain systems.

Reducing the value of the proportional gain term will normally give more stable operation but with slightly degraded speed-holding performance.

The slip limit parameter (P35) can be used to limit the maximum permissible deviation between the instantaneous value of actual frequency and the output frequency.

6.2.4 Slip Limit (P35)

The slip limit parameter (P35) allows the difference between the actual frequency (from the tachometer) and the inverter output frequency to be limited to a maximum level. This may be used to prevent motor stalling under overload conditions.

6.2.5 Sample Rate (P36)

This parameter allows the rate at which the actual frequency value used by the speed regulator is updated to be changed in 30 ms increments. When P36 is set to 001, the value is updated every 30 ms; when it is set to 002 it is updated every 60 ms, etc.

Longer sample rates may be required in applications where electrical noise is present on the analogue feedback signal or where the value of the analogue signal only responds slowly to changes in inverter/motor frequency.

7. QUICK REFERENCE GUIDE

7.1 Connections

Terminal	Function	Remarks
1	0 V Connection	
2	+15 V	
3	Run Connection	Apply voltage or connect to +15 V to run
4	Trip	Normally closed trip input when P05 = 4, etc.
5	Forward / Reverse	Apply voltage or connect to +15 V to reverse
6	10 V	
7	Frequency Adjust Voltage	 10k Typical frequency control arrangement
8	0 V	
9	Frequency Adjust Current	0 – 20 mA or 4 – 20 mA input
10	0 V	
11	Frequency / Current Indication	Output for frequency (F_{max}) or current (I_{max}) monitor
12	Tachometer	Analogue tachometer or sensor input
13	Jog	External jog button connection
14	A	} RS485 serial connection
15	B	
16	P	
17	^	
18	v	} Push-button connections
19	Fault Indication NO	} Fault relay output
20	Fault Indication Common	
21	Fault Indication NC	
22	0 V	

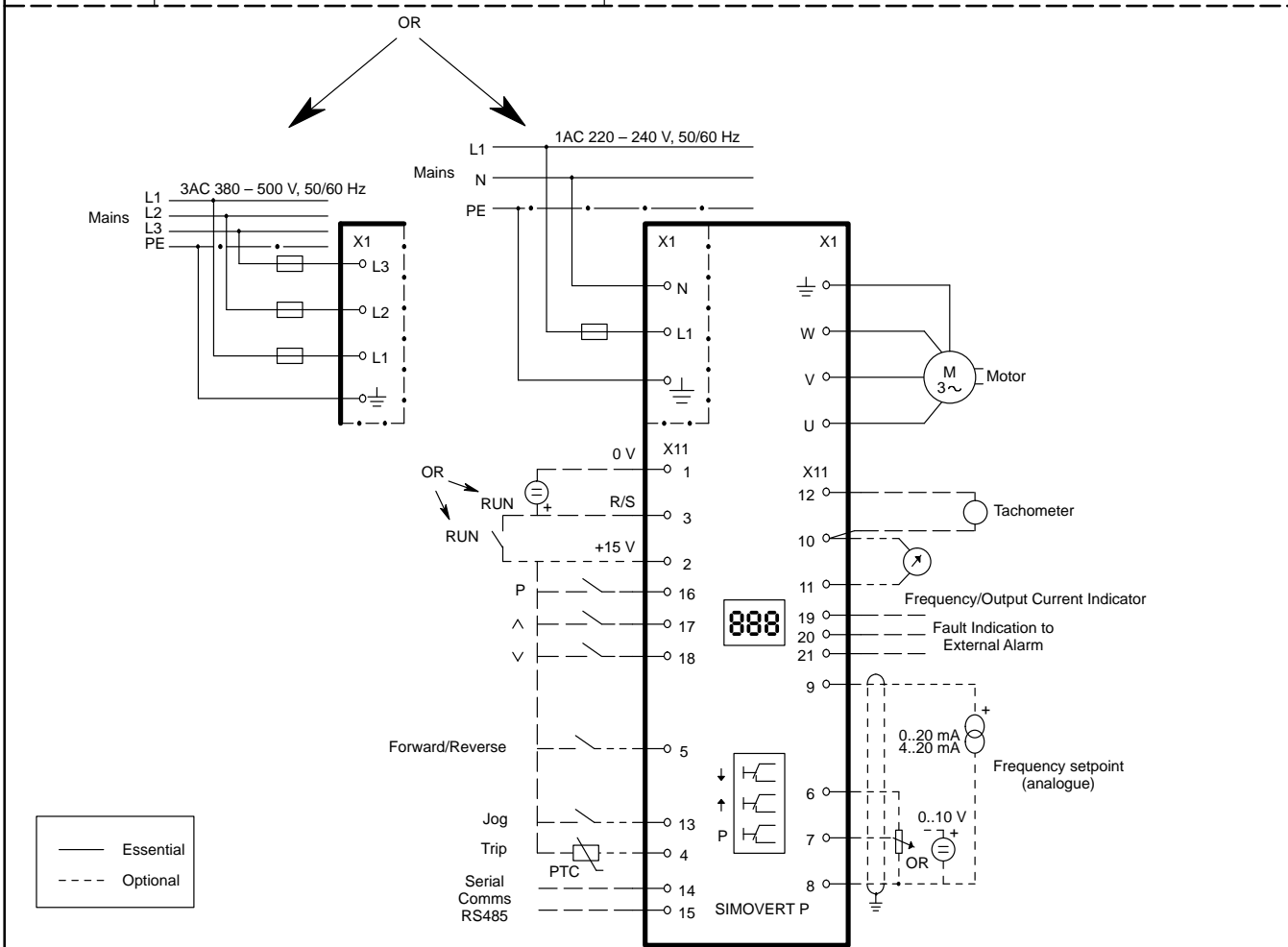

7.2 Parameter List

Parameter	Description	Value Range	Default Settings [] – N. America Only
P00	Frequency, output current or fault code		
P01	Low frequency voltage boost	00.0 – 30.0%	00.0
P02	Ramp-up time to maximum frequency	00.0 – 400 s	10.0
P03	Ramp-down time from maximum frequency	00.0 – 400 s	10.0
P04	Frequency control mode selection	000 – 009	000
P05	RUN/STOP mode	000 – 009	000
P06	Voltage to frequency curve selection	000 – 006	000 [001]
P07	Minimum frequency	00.0 – 399 Hz	00.1
P08	Maximum frequency	00.1 – 400 Hz	50.0 [60.0]
P09	Digital frequency setpoint adjustment	00.0 – 400 Hz	50.0 [60.0]
P10	Analogue frequency setpoint adjustment	080 – 240%	100
P11	DC injection braking	00.0 – 20.0%	00.0
P12	Jog	00.1 – 400 Hz	05.0
P13	Slip compensation	00.0 – 20.0	00.0
P14	Display status / Analogue output	000 – 003	000
P15	Voltage to frequency relationship: knee point	00.1 – 400 Hz	50.0 [60.0]
P16	Voltage to frequency relationship: curve type	000 or 001	000
P17	Current limit	00.1 – rated output	1.1 x
P18	Overload limit	01.0 – 03.0	01.5
P19	Automatic boost	000 – 003	000
P20	Serial interface selection	000 – 003	000
P21	Serial interface address	000 – 030	000
P22	Serial interface parity and baud rate	000 – 008	000
P23	Digital input response speed	000 or 001	000
P24	Fixed frequency mode selection	000 – 002	000
P25	First fixed frequency	00.0 – 400	00.0
P26	Second fixed frequency	00.0 – 400	00.0
P27	Third fixed frequency	00.0 – 400	00.0
P28	Fourth fixed frequency	00.0 – 400	00.0
P29	Skip frequency	00.0 – 400	00.0
P30	Tachometer mode	000 – 004	000
P31	Tachometer scale factor	00.1 – 999	50.0
P32	Feedback compensation: proportional term	000 – 999%	050
P33	Feedback compensation: integral term	000 – 250%	000
P34	Feedback compensation: differential term	000 – 250%	000
P35	Tachometer slip limit	00.0 – 20.0 Hz	05.0
P36	Tachometer sample rate	001 – 200	001
P37	Display tachometer frequency reading	000 – 400	n/a
P40	Switching frequency select	000 – 002	002
P41	Parameter default values	000 or 001	000 [001]
P42	Auto reset mode	000 – 002	000
P43	Ramp smoothing	000 – 100%	000
P44	Tachometer Interface Unit	000 – 004	000
P45	Clear Text Operator Panel language	000 or 001	n/a
P48	Fault code	000 – 011	n/a
P49	Hardware type		
P50	Software version		
P51	Customer-specific variants	000 – 255	000
P52	Current monitor scaling factor	001 – 200%	100

7.3 Fault Codes

Code	Meaning
F00	Excessive load current or excessive link voltage. Low line voltage (6SE21**–3AA21 only).
F01	Excessive heatsink temperature.
F02	Corruption of parameterisation data in the non-volatile memory.
F03	Faulty operation of A–D converter or excessive tachometer feedback voltage.
F04	P07 set to a higher value than P08.
F05	P09 outside the limits set by P07 and P08.
F06	Fault on control board.
F07	Value of P25 > P08 setting or < P07 setting.
F08	Value of P26 > P08 setting or < P07 setting.
F09	Value of P27 > P08 setting or < P07 setting.
F10	Value of P28 > P08 setting or < P07 setting.
F11	Inverter tripped externally via X11.4 input.

This page is intentionally blank